



SHINKA CONTROL SYSTEM
Installation and Operating Manual

EN

SHINKA



SAFETY SYMBOLS	3	SUMMER/WINTER MODE	34
GENERAL WARNINGS	3	ECONOMY MODE	35
INFORMATION	4	SETPOINT DEFINITION	36
FEATURES	5	START CONSENT	37
CONTROL BOARD	5	WATER VALVE	38
I/O MAPPING	6	VENTILATION	40
SHINKA TOUCH	7	ELECTRICAL RESISTANCE	42
INSTALLATION	8	DEHUMIDIFICATION CONTROL LOGIC	43
ASSEMBLY DIAGRAM	8	NETWORK AND CONNECTIVITY	44
PROBE INSTALLATION	9	RULES FOR CORRECT WIRING	44
SHINKA ASSEMBLY	11	CONNECTIVITY	44
SHINKA WIRING	12	SHINKA INTEGRATION WITH A BMS SYSTEM	48
USER INTERFACE	13	MAPPING	50
INITIAL CONFIGURATION	13	COIL STATUS	50
PLANT CONFIGURATION	15	INPUT STATUS	51
MANAGEMENT MENU	19	INPUT REGISTER	53
FANCOIL MANAGEMENT	20	HOLDING REGISTER	54
NOTIFICATIONS	21	ALARMS	56
INTERACTIONS IN THE INTERFACE	22	WIRING DIAGRAMS	57
MENU	23		
SHINKA OPERATIONAL DETAILS	30		
UNIT OPERATION	33		
PROBE SELECTION	33		
ACTIVATION LOGIC	33		
LIMITATIONS FROM SOFTWARE	34		

SAFETY SYMBOLS



READ CAREFULLY



CAUTION





DANGER VOLTAGE

GENERAL WARNINGS



TRANSLATION OF ORIGINAL LANGUAGE INSTRUCTIONS



Read all the information in this manual. Pay attention to the parts marked with the safety symbols , , and . Failure to follow the instructions will result in personal injury or damage to the equipment.



Disconnect the power supply before performing any work on the equipment.



Maintenance is reserved for a Manufacturer's Authorised Service Centre or qualified technical personnel.

Electrical equipment must be separated from household waste. Do not dismantle the system on your own. System dismantling must be carried out by qualified technical personnel.

The equipment must be taken to a specialised centre for recovery and recycling. Follow the regulations in force in the country of use.

Upon receipt of the equipment, check its condition. Check that it has not suffered any transport damage.

In case of malfunctions, please consult this manual. If necessary, contact the nearest **DAIKIN** service centre.

Failure to follow the instructions in this manual will immediately invalidate the warranty.

DAIKIN disclaims all liability in the event of:

- Installation of equipment by unqualified personnel
- Damage resulting from improper use
- Use in impermissible conditions
- Failure to follow the instructions in this manual
- Lack of planned maintenance
- Use of non-original spare parts



This equipment must not be used by children or by persons with physical, sensory or mental impairments, who are inexperienced or unprepared, without supervision.

Installation and maintenance are reserved for qualified technical personnel, in accordance with current regulations.

INFORMATION

This manual includes proprietary information. **DAIKIN** retains all rights.

Do not reproduce or photocopy this manual, in whole or in part, without the written consent of **DAIKIN**.

The Customer may only use this manual for the purpose of installation, operation and maintenance of the equipment to which the manual refers.

The Manufacturer declares that the information in this manual is congruent with the technical and safety specifications of the equipment to which the manual refers.

The drawings, diagrams and technical data shown are up to date at the date of publication of this manual.

The Manufacturer reserves the right to make changes or improvements to this manual without prior notice.

The Manufacturer accepts no liability for direct or indirect damage to persons, property or pets resulting from the use of this manual or the equipment under conditions other than those intended.

In addition, the authorised technical personnel must carry out all work in compliance with the legal provisions on safety in the workplace. The equipment in question is an integral part of a larger system that includes other components, depending on the final design and mode of use. Therefore, the user and the assembler must assess the risks and the respective preventive measures.

FEATURES

The main components of the control system are:



FWEDA control board



Shinka Touch

CONTROL BOARD

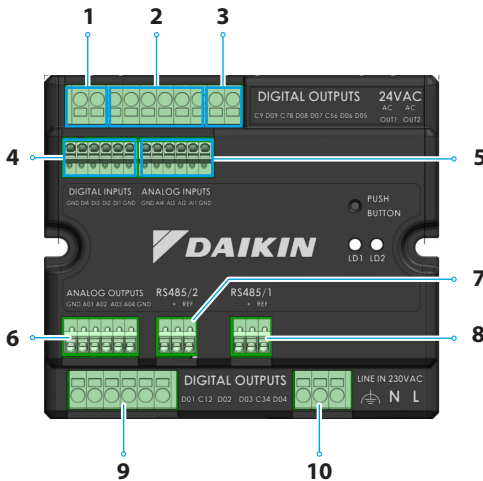

Ref.	Element
1	Digital relay output
2	Digital relay output
3	24VAC auxiliary power supply
4	Energized contact
5	NTC10K@25°C temperature probes
6	Modulating analogue output 0-10V
7	Modbus RTU
8	Modbus RTU
9	Digital relay output
10	Main power supply 230VAC

Technical Specifications

Supply voltage	230 VAC - 50/60 Hz
Transport temperature	-10 to 60 °C
Maximum absorption	500 mA
Nominal absorption	60 mA
Operating temperature	0 to 45 °C
Relay type	NO 5A@277V (resistive) Maximum body temperature 105°
Digital input	1.8 micro-interruption sourcing
Protection class	IP20
Dimensions	116.5 x 102 x 52 mm
Temperature probes	NTC 10k
Maximum cable cross-section for regular terminals	1.5 mm ²

Maximum cable cross-section for control terminals	1 mm ²
Pollution class	Class II
Heat and fire resistance category	IEC/EN 60335-1
EMC standards	EN IEC 61000-6-2 EN IEC 61000-6-3 EN IEC 60730-1 EN IEC 60730-2-9 ETSI EN 301 489-1 (V.2.2.3) ETSI EN 301 489-3 (V.2.3.2) ETSI EN 301 489-17 (V.3.2.4)
Communication specifications	WiFi 2.4GHz 802.11.b/g/n Bluetooth 5 (LE) N.02 RS485 NFC Forum Type 5 ISO 15693

I/O MAPPING

Terminal	I/O	Type	Function
Digital outputs	C9		Common
	DO9	250V - 5A	Programmable
	C78	-	Common
	C8	250V - 5A	Programmable
	DO7	250V - 5A	Programmable
	C56	-	Common
	DO6	250V - 5A	Heating valve actuator or electric heater
	DO5	250V - 5A	Cooling valve actuator
24VAC	OUT1	24VAC	
	OUT2	24VAC	
Digital inputs	GND	-	Common
	DI4	Energized contact	Dehumidification by contact
	DI3	Energized contact	Economy by contact
	DI2	Energized contact	Remote ON / OFF
	DI1	Energized contact	Remote mode switching
	GND	-	Common
	GND	-	Common
Analog inputs	AI4	NTC10K@25°C	Room temperature
	AI3	NTC10K@25°C	Supply air temperature
	AI2	NTC10K@25°C	Water temperature #2 (4 pipes)
	AI1	NTC10K@25°C	Water temperature #1 (2 pipes)
	GND	-	Common

Terminal	I/O	Type	Function
Analog outputs	GND	-	Common
	AO1	0-10VDC	Fan speed
	AO2	0-10VDC	Cooling valve actuator
	AO3	0-10VDC	Heating valve actuator
	AO4	0-10VDC	Programmable
	GND	-	Common
	RS485/2	B-	RS485 - 2
A+		RS485 - 2	Modbus Data (+)
REF		RS485 - 2	Modbus REF
RS485/1	B-	RS485 - 1	Modbus Data (-)
	A+	RS485 - 1	Modbus Data (+)
	REF	RS485 - 1	Modbus REF
Digital outputs	DO1	250V - 5A	Fan Step 1
	C12	-	Common
	DO2	250V - 5A	Fan Step 2 (or not used)
	DO3	250V - 5A	Fan Step 3 (or Fan Step 2)
	C34	-	Common
	DO4	250V - 5A	Fan Step 4 (or Fan Step 3)
	Line IN 230 VAC	F	230VAC
N			Neutral
T			Earth

SHINKA TOUCH

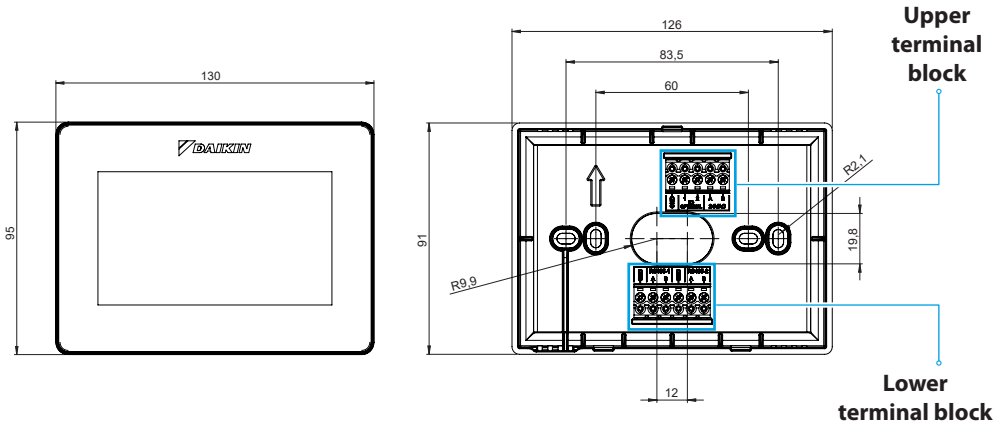

Upper terminal block		Lower terminal block	
GND	RS485-1 - GND	Default setting = Slave Set up for connection with: <ul style="list-style-type: none"> BMS/Supervisor Shinka Zone (for Touch/Sense models) 	
IO1 (Optional for Shinka Sense)	RS485-1 - A		
IO2 (Optional for Shinka Sense)	RS485-1 - B	Default setting = Master Set up for connection with: <ul style="list-style-type: none"> FWEDA control board Shinka Touch/Sense (for zone models) 	
24VAC - A	RS485-2 - GND		
24VAC - B	RS485-2 - A		
	RS485-2 - B		

Technical Specifications

Display	TFT LCD RGB 480x272, 16bit, 4.3"
Supply voltage	24 VAC
Max. absorption	110 mA
Operating temperature	0 to 50 °C
Temperature sensor	± 0.2 °C
Relative humidity sensor	± 2%
Protection class	IP30
Dimensions	130mm x 95mm x 22.5mm
Communication specifications	WiFi 2.4GHz 802.11.b/g/n Bluetooth 4.2 N.02 RS485

INSTALLATION



Disconnect the power supply before performing any work on the equipment.

The installation kit includes:

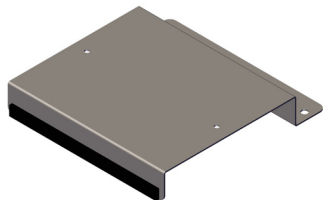

Bracket plus vibration-damping seal

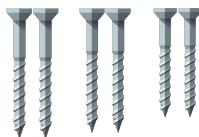

(1) (2) (3)

Fixing screws



Control board

Screws:

- (1)** Self-threading screws (bracket fastening to fancoil side)
- (2)** Self-threading screws (control board fastening directly to the electrical box on the FCU) → for models FWF-D/FWC-D/FWE-D/F
- (3)** Self-threading screws (fastening control board to bracket) → for models FWV/FWZ/FWL/FWR/FWM/FWS/FWB/FWP/FWN/FWD/FWH/FWI

ASSEMBLY DIAGRAM

See the image opposite for assembly.

When fixing the control board to the fancoil, place the fixing bracket on the side opposite the water collector inlet.

If the terminal box is overlapped in the position for mounting the bracket, move the main terminal box of the fancoil to the bottom by drilling holes.

Ferrules must be used for wiring of the control board. See wiring diagram for wiring.

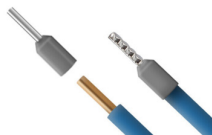

Cable size:

- Small clamps: 1.5 mm
- Large clamps: 2.5 mm

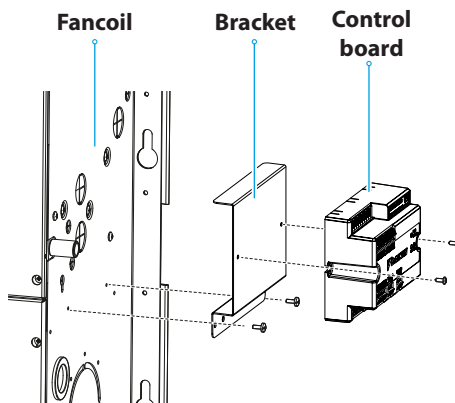

Assembly diagram

PROBE INSTALLATION

The Shinka control system handles the following probes:

- **Air temperature reading probe:** integrated inside the user interface. Requires no special operations for installation
- **FWTSKA remote air probe** (optional and alternative to the previous one): connected to the power board to read the temperature of the air suctioned in by the unit. The probe can be positioned anywhere else in the room subject to temperature control
- **FWTSKA water temperature reading probes** (optional): one or two probes can be connected depending on whether the terminal is connected to a 2-pipe or 4-pipe system

- **Humidity probe:** for reading the relative room humidity integrated in the user interface
- **Supply air probe** (optional): for reading the supply air temperature FWSSKA



Probe cables must be positioned away from power cables (230V) to avoid disturbances and malfunctions.

Water probe installation

For connection, follow the wiring diagram in the Analog input section.

The location of the probes will be in different place depending on the model and/or connected valves. Below is a table with the information.

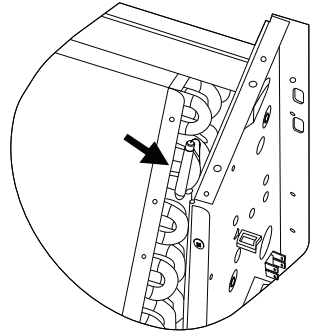

Model	Valve type	Location
FWV-L-M-Z-R-S	No valve	<ul style="list-style-type: none"> • One probe: place in the exchanger sump • Two probes: place in the respective wells of the hot and cold exchangers
	2-way valve	<ul style="list-style-type: none"> • One probe: place in the exchanger sump • Two probes: place in the respective wells of the hot and cold exchangers
	3-way valve	<ul style="list-style-type: none"> • One probe: place on the hot branch at the valve inlet • Two probes: Position the probes in the respective inlet branches of the hot and cold valves
FWD-N-B-P-H-I FWE-D/F-FWC/F-D	With or without valve	<ul style="list-style-type: none"> • One probe: Place on the pipe at the inlet of the exchanger • Two probes: place on the inlet pipe of the respective hot and cold branches

Air probe positioning (supply)

The supply air probe measures the temperature at the outlet of the fancoil.

The **FWSSKA** installation kit includes a small plastic container to be placed directly on the exchanger in a central position.

Remote outside air temperature probe

Use the supplied adhesive plastic probe holder. This operation is necessary in order to mount the outside air probe.

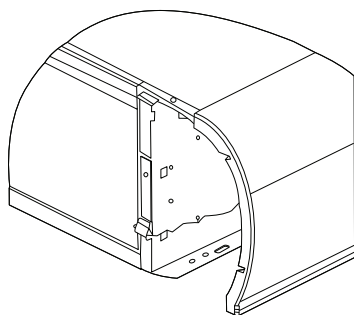

Fan coil unit without plinth

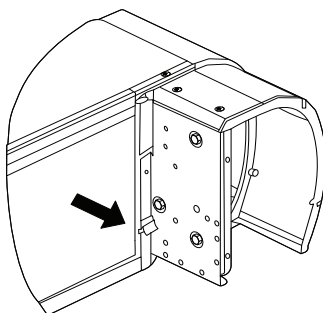

Fan coil unit with plinth

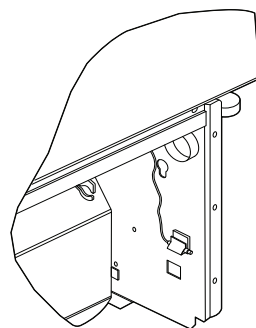

Fan coil unit with front suction

Probe wiring

See the wiring diagrams (see **WIRING DIAGRAMS**) for probe wiring.

Below is a summary table of the connection pins.

Pin	Type	Function
M	-	Common
AI1	NTC10K@25°C	Water temperature #1 (2 pipes)
AI2	NTC10K@25°C	Water temperature #2 (4 pipes)
AI3	NTC10K@25°C	Supply air temperature
AI4	NTC10K@25°C	Room temperature
M	-	Common

SHINKA ASSEMBLY

The Shinka user interface must be coupled with the fancoil power board (FWEDA) for the control system to function properly Daikin.

Contents of the box:

- Front display panel
- Rear panel with terminal blocks

Install the equipment on an internal wall away from heat sources, direct sunlight, draughts and doors. The ideal position is about 1.5 metres above the floor for accurate temperature measurement.

Avoid:

- Direct exposure to sunlight
- Proximity to the fancoil air jet
- Installation in places covered by fabrics or other materials
- Proximity to water sources
- Complete recesses in walls

Follow these instructions to avoid incorrect probe readings.

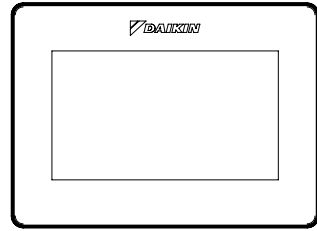

Front panel

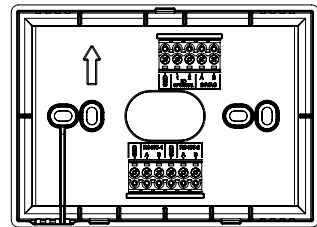

Back panel

Wall mounting

Wall mounting requires fixing the base of the Shinka directly to the wall surface.

Follow the steps below:

1. Use the base plate of the equipment as a template and mark the points for the fixing holes on the wall. Make sure to keep the plate perfectly horizontal with a spirit level.
2. Drill the holes in the marked places. Position the base plate and fix it to the wall. Tighten screws until stable and secure.
3. Feed the electrical wires through the central opening of the base plate. Connect the electrical wires to the appropriate terminals following the wiring instructions on the connectors.
4. Hook the front panel of the user interface onto the base plate. Ensure that the front panel of the user interface is secure and properly positioned.

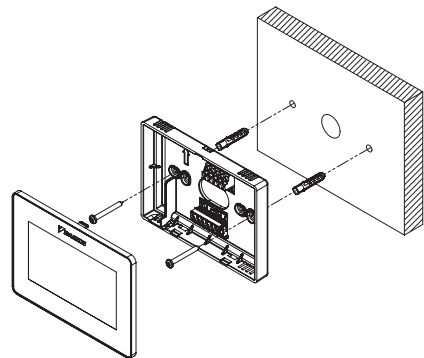

Wall installation

Mounting with electrical box (not supplied)

Electrical box mounting is suitable for walls that already have a standard junction box. This mode allows secure and stable fixing in the presence of an electrical housing.

Follow the steps below:

1. Align the base plate of the equipment with the holes in the electrical box. Ensure that the base plate is perfectly centred and horizontal.
2. Use electrical box screws to fix the base plate directly to the electrical box. Ensure that the base plate is well anchored to prevent movement of the Shinka.
3. Insert the wires into the electrical box and feed them through the central opening of the base plate. Connect each wire to the specified terminals on the device according to the wiring diagram provided.
4. Hook the front panel of the user interface onto the base plate mounted on the electrical box. Ensure that the front panel of the user interface is secure and properly positioned.

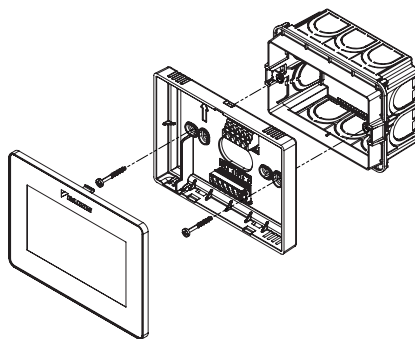

Installation with electrical box 503

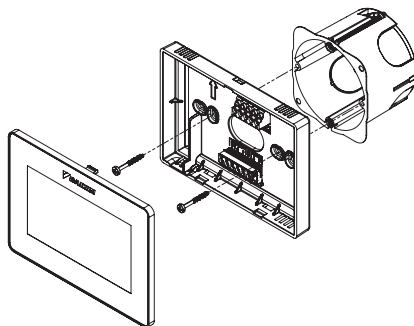

Installation with electrical box 502

SHINKA WIRING

Place the power and data cables inside the template.

The 24VAC (AC) power supply is located at the top. However, the Shinka can also be powered at 24VDC by using an external transformer.

The Modbus protocol is used for communication. There are two ports in the terminal box at the bottom of the Shinka.

The nomenclatures identifying the doors are: A+_1, B-_1, GND, A+_2, B-_2, GND.

Connect the port marked 2 to the **FWEDA** control board and connect port 1 to the BMS (if present).

Connect A+, B- and GND to the **FWEDA** control board.



In the case of initial configuration via the user interface, see section **NETWORK AND CONNECTIVITY** before wiring the RS485.

USER INTERFACE

This section describes the initial start-up and configuration procedure of the Shinka control system.

INITIAL CONFIGURATION

When the system is switched on for the first time, the display shows the image shown opposite.

Initial configuration requires the following parameters to be set:

- Desired language
- Brightness
- Date
- Time

Upon completion of this step, you will be asked to configure the system.

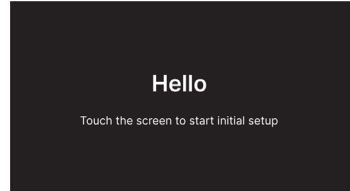

Language setting

Press the arrows to display the available languages:

- Italian
- English
- French
- Spanish

Then press **Continue** to confirm your selection.

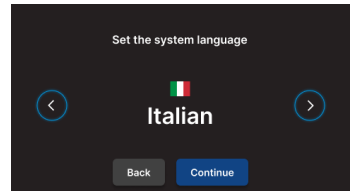

Brightness setting

Move the slider on the horizontal bar to increase or decrease the brightness of the display.

Note: the display must be switched on to adjust brightness.

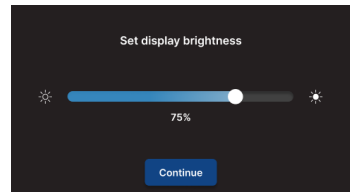

Date setting

Select the desired format: DD/MM/YY or MM/DD/YY.
Then open the **Date** drop-down menu to set the date.

Use the arrows to change the date.
Press ✓ to confirm the setting.

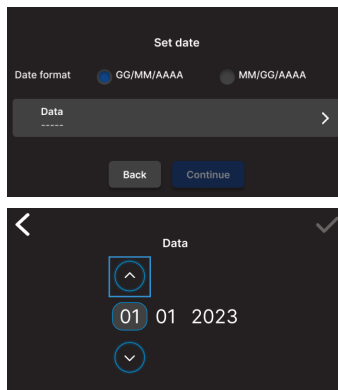

Time setting

Select the format: 12 hours.
Then open the **Hour** drop-down menu to set the time.

Use the arrows to change the time.
Press ✓ to confirm the setting.

Press **Conclude**.

Note: initial configuration of the control system is now completed.

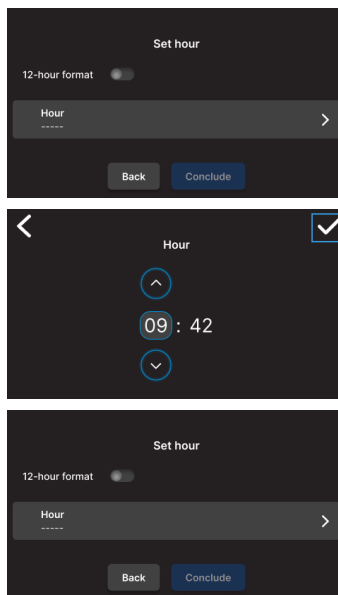

PLANT CONFIGURATION

After the initial configuration is complete, the system prompts the installer to configure the system.

The system can be configured as a **single zone**, consisting of a group of fancoils, or as a **multi-zone**, consisting of a group of zones.

The installer must choose between two configuration modes:

- Via **Daikin Shinka Manager App**
- Via **Shinka controller**

Configuration via App

The system displays a QR code needed to download the application from the store.

If the installer presses **Continue**, the system generates a Wi-Fi network.

To connect the smartphone to the Shinka, the installer must follow the instructions on the display.

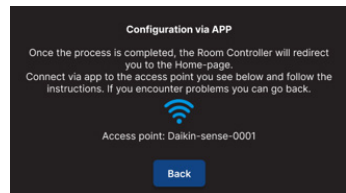
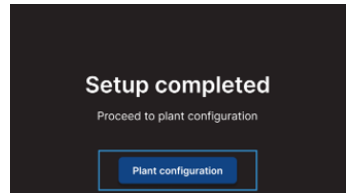

Configuration via Shinka

To configure a single-zone system, the installer must physically connect one fancoil board (FWEDA) at a time to the Shinka interface, before starting the device search.

For more information on Modbus network wiring, see section **NETWORK AND CONNECTIVITY**.

During pairing, the Shinka interface recognizes the connected fan coil (if correctly configured with the factory default Modbus address) and then the system assigns the new initialization Modbus address to the fan coil board.

Once the initialization procedure on the first fan coil board has been completed, the installer technician can disconnect the Shinka interface from the board just configured and proceed with the next one. Each new fan coil configured in the Modbus chain receives a numerical address one unit higher than the previous fan coil.

At the end of the configuration of all control boards, the Shinka will be ready for communication with each of them according to the number of configuration processes successfully completed.

In the configuration process, the Shinka interface handles the following error messages:

- **Modbus communication problems**
 - **Connection not detected:** check that Modbus line wiring is correct. Check that the addresses assigned to the devices in the Modbus chain are all different
 - **Connection detected but not tested:** repeat the test or choose to ignore the warning. In the latter case, the system saves the configuration process and requires a manual restart of the fancoil
- **Unit composition:** the process was saved, but an error occurred. If the error occurs again, contact customer service
- **Generic error:** the Shinka interface displays the error message "internal device problems". In this case, it is necessary to restart the device and start the configuration from the beginning.

Once the pairing is complete, you are asked to configure the fancoil. Press **Configure** to proceed.

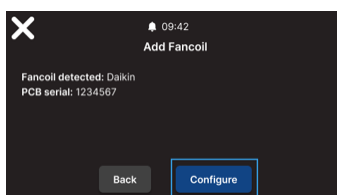
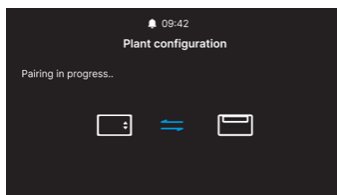

The system performs the configuration by means of a guided process through the following points:

- **Basic unit composition**
- **Advanced unit composition**

Both configurations have default values, as shown in the table below.

Unit composition - basic	Default	Possible values
Number of pipes	2 pipes	<ul style="list-style-type: none"> • 2 pipes • 4 pipes
Ventilation	Step	<ul style="list-style-type: none"> • Step • Modulating
Resistance	No	<ul style="list-style-type: none"> • Yes • No
Valve	No	<ul style="list-style-type: none"> • No • ON-OFF • Modulating • 6-way modulating

With **4-pipe unit configuration** it will not be possible to configure:

- Electrical resistance
- The modulating 6-way valve

Unit composition - advanced	Default	Possible values
Motor speed no.	3 speeds	<ul style="list-style-type: none"> • 3 speeds • 4 speeds • Modulating
Summer / Winter switching	Display / Serial	<ul style="list-style-type: none"> • Display / Serial • Digital input • Auto on water probe temperature • Auto on air probe temperature (see SUMMER/WINTER MODE)
Fancoil remote probe	No	<ul style="list-style-type: none"> • Yes • No
Supply air probe	No	<ul style="list-style-type: none"> • Yes • No
Water probe	No	<ul style="list-style-type: none"> • No • A • Two
ON / OFF from contact	No	<ul style="list-style-type: none"> • Yes • No
Economy from contact	No	<ul style="list-style-type: none"> • Yes • No
Dehumidification from contact	No	<ul style="list-style-type: none"> • Yes • No

Unit composition - advanced	Default	Possible values
Digital outputs (DO7-8-9)	Not used	<ul style="list-style-type: none"> • Not used • ON/OFF • Hot or cold request • Cold request • Hot request • Operating mode • Alarm presence • High room temperature • No heating consent • No cooling water consent • From external supervisor • Economy active • Antifreeze active • Electrical resistance active
Ventilation mode in standby (See Fan mode in standby)	Standard	<ul style="list-style-type: none"> • Standard • Always ON • Always OFF
Ventilation speed in standby (See Fan mode in standby)	Super minimum or 20%	<ul style="list-style-type: none"> • Super minimum • Minimum • Medium • Maximum or 0/100%

When you have finished configuring the fancoils, press **Conclude**.

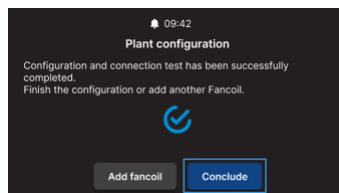

After completing the system configuration, a possible BMS can also be configured.

Select **BMS**.

A menu wizard for entering network parameters is shown:

- Address
- Baud rate
- Parity
- Stop bit

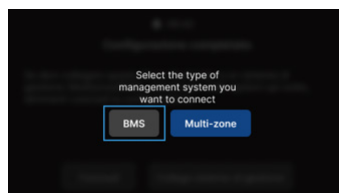

MANAGEMENT MENU

The Home interface displays a variety of data and commands. This section provides a brief description of these elements.

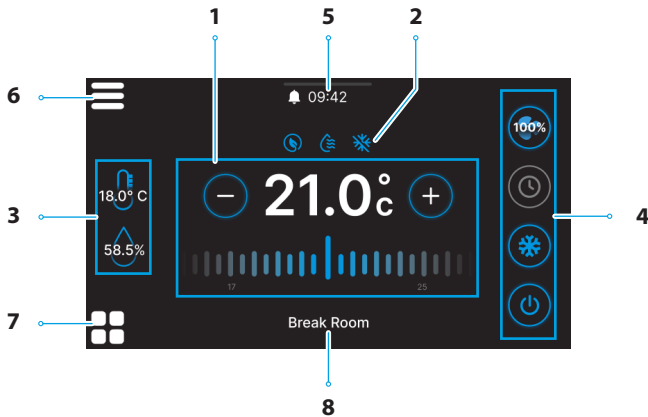

Ref.	Element
1	Control target. = Press to increase value = Press to decrease value
2	Service information (active functions). = Economy = Active dehumidification = Antifreeze
3	Real-time information of Shinka measurements. 58.5% = Humidity 18.0°C = Room temperature

Ref.	Element
4	Quick settings. <ul style="list-style-type: none"> • = ON / OFF • Operating mode <ul style="list-style-type: none"> ○ = Cooling ○ = Heating • = Scheduling • Ventilation <ul style="list-style-type: none"> ○ = 3 Steps ○ = 4 Steps ○ = Modulating ○ = Auto
5	Notifications. <ul style="list-style-type: none"> • = Alarms active • 09:42 = Timetable • = Drop-down menu for notifications
6	= Shinka Menu
7	= Fancoil management
8	Zone name

The behaviour of the ventilation icon (Ref. 4) in Home varies according to the type of fancoil present in the area controlled by Shinka:

- **Zones with only 3-step fancoils:** the interface displays an icon corresponding to the 3 steps. The icon is not editable
- **Zones with only 4-step fancoils:** the interface displays an icon corresponding to the 4 steps. The icon is not editable
- **Zones with modulating fancoils only:** the system uses modulating management mode by default. The operator can change the modulating fan management by setting it to 3 steps, via the management menu. To locate the specific item to be modified, please refer to the related section **Management**
- **Zones with mixed-type fancoils (3-step, 4-step and/or modulating):** the interface always displays an icon corresponding to the 3 steps. The icon is not editable

If the ventilation configuration changes, e.g. by changing the ventilation type of a fancoil or adding a new fancoil, the Home icon automatically updates to reflect the new logic. This update occurs after Shinka periodically reads the data.

FANCOIL MANAGEMENT

Press the  icon on the Home page to enter the menu that allows access to both the unit composition and the operation conditions of each fancoil. The system allows a maximum of 30 fan coils to be set.

To access the two options, select a fancoil displayed in the menu.

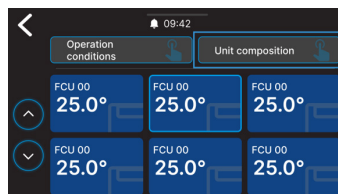

In the **operation conditions** menu, the following information is available for reading:

- Status
- Ventilation
- Mode
- Setpoint temperature
- Room temperature
- Remote fancoil temperature
- Control temperature
- Supply temperature
- Cold/hot water temperature
- Hot water temperature
- Valve (% or ON / OFF)
- Resistance active
- Room humidity (only if Shinka controller present)
- Dehumidifies

- Dehumidification setpoint
- Economy
- Antifreeze
- Antifreeze temperature

In the **unit composition** menu, it is possible to view:

- Basic composition
- Advanced composition

To change these, it will be necessary to enable maintainer mode (see **Maintainer mode**).

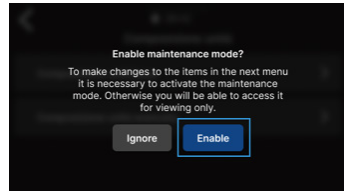

NOTIFICATIONS

Drag the multi-function bar at the top of the Home page downwards to access a series of quick settings.

Notifications can be managed. These are divided into:

- **Alarm active:** highlighted in red and identifies a problem classified as critical
- **Active warning:** highlighted in orange and identifies a problem classified as non-critical
- **Alarms or warnings no longer active:** shown in grey.

The maximum number of notified alarms is 5.

Click on **Alarms archive** to access the history of the last 50 notified alarms. Notified alarms are displayed in chronological order.

Warnings can be removed by swiping on the warning itself.





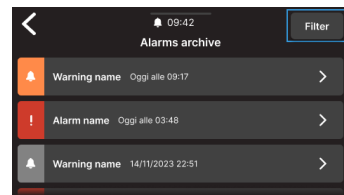
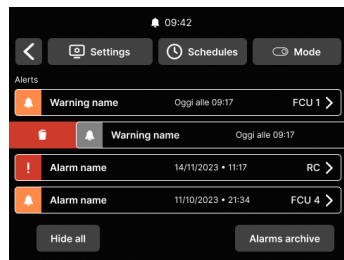

In addition, in this screen you can quickly access the following using the icons at the top:

- **Settings:** where you can change device settings (see **Settings**)
- **Schedules:** where programs can be set up and edited (see **Schedules**)
- **Mode:** where the restricted mode of the Shinka and fancoil functions can be activated (see **Mode**)



INTERACTIONS IN THE INTERFACE

Shinka has different menu types but the structure and interaction remain common.

Graphic element	Name	Description
	Slider	Used for percentage adjustments. Press and drag the white slider to increase or decrease the percentage.
	Single selection button	Used in configuration. The blue coloured circle indicates that a selection has been made.
	Modifiable set point	Used to change control targets or hysteresis. Press  or  to adjust the associated setpoint.
	Limits	Used to define an interval. In this case, the range is between 5°C and 30°C. Press and drag the white sliders to move them to the desired positions.

MENU

Press the icon on the Home screen to display the menu for accessing various settings:

- Management
- Schedules
- Alarms archive
- Settings
- Change zone
- Device info
- Network and connections
- Mode

Management

Press **Manage** to access:

- Advanced adjustments
- Master control
- Rename zone

Below is a detail of the pages.

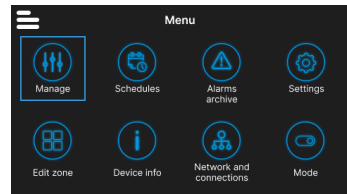

Advanced controls

The main values that can be set and their ranges are shown in the table below.

Parameter	Sub-parameter	Description	Range of values	Default
Cooling set	N/D	Sets the temperature for cooling	14°C to 28°C	14°C to 28°C
Heating set	N/D	Sets the temperature for heating	18°C to 32°C	18°C to 32°C
Dehumidification set	Target dehumidification	Sets the desired humidity level	0% to 100%	45%
	Hysteresis dehumidification	Set the humidity difference to reactivate dehumidification	0% to 50%	5%
	Humidity set	Set the minimum and maximum humidity limit	0% to 100%	15% to 60%
	Humidity probe offset	Sets the offset of the humidity probe	-30% to +30%	0%
Ventilation	Modulating fan management	Sets the management mode of the zone's modulating fans	Modulating (%) Step (3 speeds)	Modulating (%)
	Minimum modulating ventilation	Sets the minimum modulating ventilation value	20%	0% to 50%
	Maximum modulating ventilation (cooling)	Sets the maximum modulating ventilation value (cooling)	100%	50% to 100%
	Maximum modulating ventilation (heating)	Sets the maximum modulating ventilation value (heating)	100%	50% to 100%

Parameter	Sub-parameter	Description	Range of values	Default
Offset	Room air probe offset (Shinka)	Sets the offset of the temperature read by the room air probe (Shinka)	-3°C to +3°C	0°C
	Room air probe offset (control board)	Sets the offset of the temperature read by the room air probe (control board)	-3°C to +3°C	0°C
	Supply air probe offset	Sets the offset of the temperature read by the supply air probe	-3°C to +3°C	0°C
	Water probe offset	Sets the offset of the temperature read by the water probe	-3°C to +3°C	0°C
	Offset heating water probe	Sets the offset of the temperature read by the water probe for heating	-3°C to +3°C	0°C
Economy	Economy hysteresis	Temperature difference to activate/deactivate economy mode	0°C to 10°C	2.5°C
	Economy activation	Sets the economy mode	Master – DIN – Both	Master
Antifreeze set	Antifreeze target	Sets temperature for antifreeze protection	0°C to 10°C	9°C
	Antifreeze hysteresis	Sets difference for antifreeze activation	0°C to 10°C	10°C
Neutral zone	N/D	Sets the neutral temperature zone	0°C to 10°C	2°C
Control temperature	N/D	Sets the control temperature	Display (Shinka) - Fancoil remote probe - Both (Medium)	Fancoil remote probe
Control consents	Cooling water consent set	Sets temperature to activate cooling water consent	0°C to 25°C	17°C
	Cooling water consent hysteresis	Sets difference to activate cooling water consent	0°C to 10°C	7°C
	Heating water consent set	Sets temperature to activate heating water consent	10°C to 50°C	37°C
	Heating water consent hysteresis	Sets difference to activate heating water consent	0°C to 10°C	7°C
	Dehumidification water consent set	Sets temperature to activate water dehumidification consent	0°C to 30°C	10°C
	Dehumidification water consent hysteresis	Sets difference to activate water dehumidification consent	0°C to 10°C	2°C

Parameter	Sub-parameter	Description	Range of values	Default
Control consents	Water valve consent set	Sets temperature to activate water valve consent	0°C to 50°C	30°C
	Valve water consent hysteresis	Sets difference to activate water valve consent	0°C to 10°C	5°C
	Resistance water consent set	Sets temperature to activate resistance water consent	0°C to 50°C	39°C
	Resistance water consent hysteresis	Sets difference to activate resistance water consent	0°C to 10°C	2°C
Default values reset	N/D	Resets the initial settings of each parameter	N/D	N/D

Control from master

From this menu, it is possible to inhibit the writing of registers when connected to BMS. Individually or as a whole, of the various associated functions.

By default, all registers are enabled for master control.

If BMS is connected, this menu can be used to inhibit writing, either individually or completely.

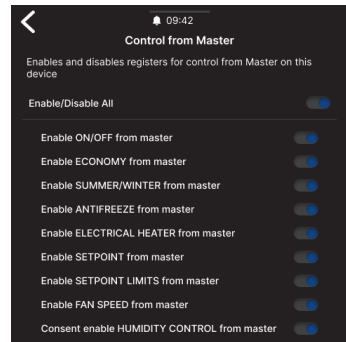

Zone name

Enter the **Manage > Rename Zone** menu to rename a zone.

To change the name of the zone:

1. Select the corresponding module
2. Enter the new name and press **Confirm**

Note: a pop-up asks for further confirmation.

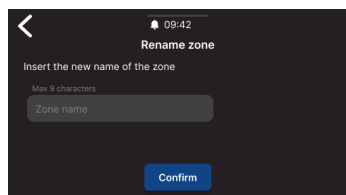
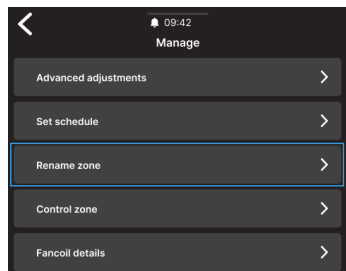

Schedules

Press **Schedules** to manage the climate in automatic mode.

From here the operator can set times to switch the system on or off, adjust the temperature and adapt the environment to daily or weekly needs. In addition, the operator can schedule periods of the year when the system remains idle to save energy and maintain comfort without manual intervention.

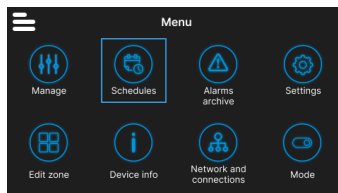

Creating a new time program

To begin, press **Temperatures**.

From here, four different comfort temperatures can be set. When the setting is complete, press **+** and follow the directions on the display to set it to your preference.

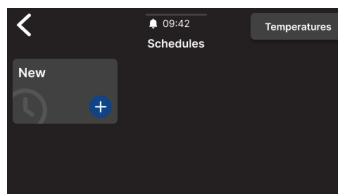

It is possible to have a maximum of 6 saved schedules.

i **Manual changes during a schedule disable its operation until the next time slot.**



In addition to time slots, switch-off periods can also be set.

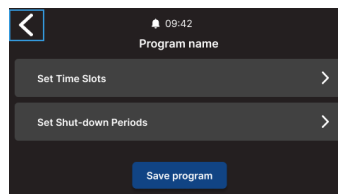

To set a scheduled shut-down day, select the desired day on the displayed calendar.

In case it is necessary to set a switch-off period, activate the **Period** function in the top right of the screen. Then select the desired period from the displayed calendar.

To activate the selected schedule, go to Home and press . If no schedule has yet been created, pressing will display a pop-up that if followed will lead to the creation of a new schedule.

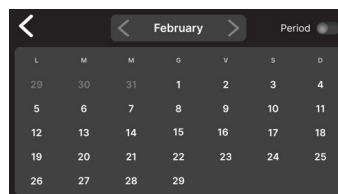

Alarms archive

Press **Alarms archive** to access the history of alarms and warnings, both active and archived.

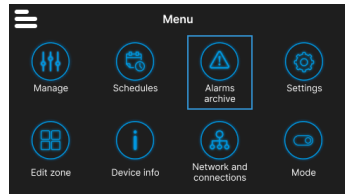

Press **Filter** to sort and display only active alarms and warnings.

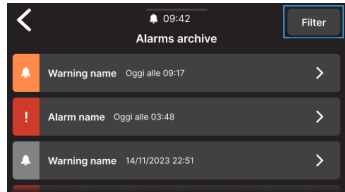

Select an alarm or warning to see its details. The status of the alarm or warning is indicated in the top left-hand corner.

Settings

Press **Settings** to adjust the general settings of the Shinka.

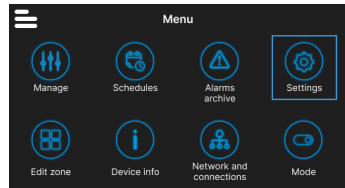

In particular, the following adjustments can be made:

Adjustment type	Description
Image (See Screensaver)	Possibility of changing the standby image (if pre-loaded via the Daikin Shinka Manager app).
Standby Timer (See Screensaver)	<ul style="list-style-type: none"> • 20 seconds • 30 seconds • 1 minute • 2 minutes
Display brightness	Changeable between 0 and 100%. In standby the brightness is forced to 10%.
Temperature units	<ul style="list-style-type: none"> • Degrees centigrade • Kelvin degrees
Date and time	Date, time and format can be changed.
Language	<ul style="list-style-type: none"> • Italian • English • Spanish • French
Maintainer mode (See Maintainer mode)	Mode for enabling full interface functions.
Activate access point	A momentary network will be activated by the Shinka to allow connection with the Daikin Shinka Manager App.
Resetting to factory settings (See Factory reset)	Restoring the initial settings of the various devices.

Edit zone

Press **Edit zone** to add or remove a fancoil.



The addition or removal of fancoils is only possible in maintainer mode (see Maintainer mode).

When adding a fancoil, press the  icon from the Home page to display that fancoil in the list associated with the zone managed by Shinka.

In case of removal, the fancoil will no longer be visible in the list of fancoils in the zone managed by the device. In addition, the removed fancoil will be reset and regain its default Modbus address (247).

However, the fancoil cannot be removed if at least one other fancoil that is not to be removed is not responding.



Fancoils that will not be eliminated must communicate correctly (no Modbus communication errors).

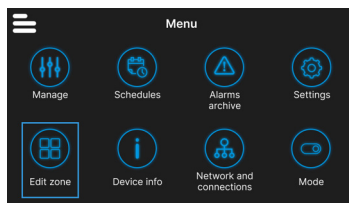

Device info

Three types of information can be displayed in this menu:

- **Shinka info:** Serial, Firmware version, MAC address Wi-Fi and Bluetooth
- **Fancoil info:** Control board serial, MAC address Wi-Fi, Bluetooth, Firmware and Application version
- **General info:** QR code with reference to the manual.

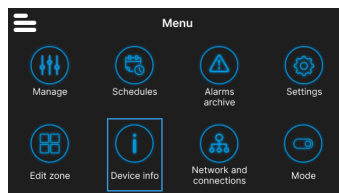

Network and connections

Press **Network and Connections** to change the Modbus address, baud rate, parity index and stop bit of individual fancoils or the Shinka controller.

The default Modbus parameters of the fancoils are as follows:

Parameter	Default value
Address	247
Baud rate (bps)	19200
Parity	NONE
StopBit	1

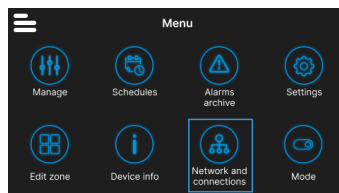

Shinka's default Modbus parameters are as follows:

Parameter	Default value
Address	246
Baud rate (bps)	19200
Parity	NONE
StopBit	1



If the user wishes to use a BMS, he/she must change the parameters of the Shinka or fancoils according to the specific requirement.

Mode

Press **Mode** to activate or deactivate certain types of modes.

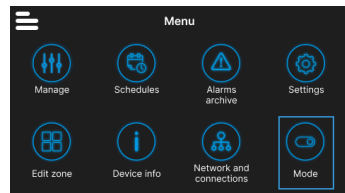

Restricted mode

To activate the restricted mode, go to the **Display** menu and activate the mode by entering the maintenance PIN.

The **restricted mode** reduces the operations that can be performed from the Shinka interface. Below is the list of operations that can be performed in restricted mode:

- Changing the setpoint: ± 2 °C
- Changing fan speed
- Changing modes
- Switching off fan coils

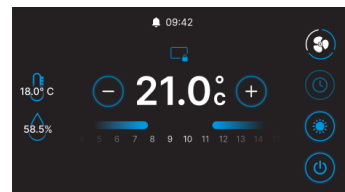

To disable restricted mode, drag the drop-down menu from top to bottom and enter the maintenance PIN again. The system disables the restricted mode after entering the maintenance PIN and automatically returns to the Home screen.

Functions

Enter the **Functions** menu to activate or deactivate specific modes.

The selectable modes are as follows:

- **Economy:** saves energy and includes an adjustment button. For details, see the related section **ECONOMY MODE**
- **Dehumidification:** enables the dehumidification function. The user can adjust this function in the menu. For details, see the related section **DEHUMIDIFICATION CONTROL LOGIC**
- **Antifreeze:** enables the antifreeze function and includes settings to manage it. For details, see the related section **LIMITATIONS FROM SOFTWARE**
- **Electrical resistance:** enables an electrical resistance to be activated. The electrical resistance will only be available on units containing it. For details, see the related section **ELECTRICAL RESISTANCE**

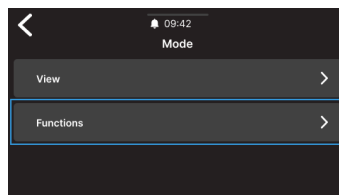

SHINKA OPERATIONAL DETAILS

Fan mode in standby

The ventilation settings in standby can be changed from the **unit composition - advanced composition** menu.

To set the fan mode in standby, go to the **unit composition - advanced composition** menu.

Fan in standby is divided into 3 modes:

- **Standard:** The fan operates according to normal control logic
- **Always ON:** when the setpoint is reached, the valve closes. The fans continue to recirculate air at the speed set by the user
- **Always OFF:** when the system reaches the setpoint, the fancoil switches off completely and ignores all other logic.

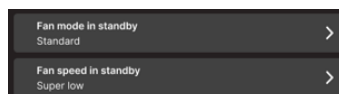

In case of ventilation in "Always ON" mode, change the fan speed via the dedicated "Fan mode in standby" setpoint.

Screensaver

Enter the menu **Settings > Standby picture** to select a customised picture to be displayed in standby mode.

Upload the image in advance with the application in order to use it.

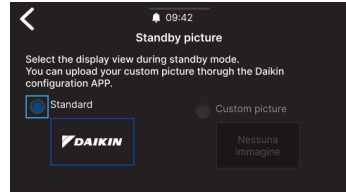

Enter the menu **Settings > Standby timer** to enter a timer after which the screensaver appears.

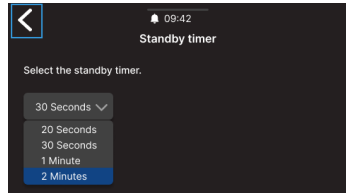

Maintainer mode

Maintainer mode provides full access to Shinka functions and settings.

To enable maintainer mode:

1. Press in Home
2. Press **Settings**
3. Select **Maintainer mode** to access the on/off screen
4. Enable maintainer mode
5. Enter the **PIN: 5392** and press the confirmation key

The maintainer mode is automatically deactivated when the Shinka goes into standby or is switched off.

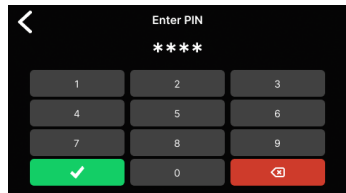
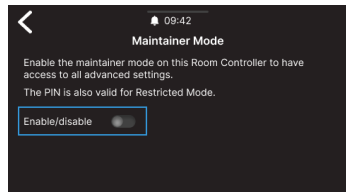

After entering the PIN, the Shinka interface will be enabled to:

- Editing zones:
 - Deleting / adding fancoils
- Advanced network configurations
 - Changing communication parameters with Fancoils
 - Changing communication parameters with BMS
- Activate / Deactivate restricted mode
 - Advanced controls
 - Management from master

Factory reset

Enter the menu **Settings > Factory Reset** to return the equipment to its factory status.

There are two types of control:

- **Reset Room Controller:** resets the controller completely, returning it to factory settings.
- **Fancoil reset:** resets one or more fancoils to factory status by means of a multiple selection.

The fan coil control board can also be reset manually, using the following procedure. Two LEDs are visibly present on the FWEDA fan coil control board. In the initial state LED1 is white, LED2 is blue. Press and hold the reset button for about 10 seconds: only LED1 will flash and, finally, both LEDs will turn orange.

Release the reset button and press it again for about 5 seconds until LED1 turns white and LED2 turns blue. Finally release the button.

The factory status represents the condition of the equipment without any configuration. In this state, the fancoils assume Modbus address 247, and Shinka does not detect any fancoils in its network.



Always reset the fancoils before Shinka. This sequence prevents Shinka from failing to communicate with the fancoils if a new pairing attempt is required.

UNIT OPERATION

PROBE SELECTION

Enter the menu **Management > Advanced Settings > Temperature Control** to select one of the indoor air reading options.

0 - From Shinka interface (room controller)

1 - From remote probe (if present)

2 - From the average of both probes

Alarm management

- **Warning:** if both probes are present and one of them is in alarm, the system generates a warning. In this case, to avoid a system shut-down, the control automatically switches to the first available working probe
- **Blocking alarm:** if both probes are in alarm, the system generates a blocking alarm that causes the system to shut down (see **ALARMS**)

ACTIVATION LOGIC

Choose from the following three modes to activate the fancoil:

- **Local / Modbus:** ON / OFF via Shinka interface or via BMS
- **From contact:** ON / OFF from DI2 to be configured in advanced unit composition
- **Antifreeze:** if antifreeze mode is active and the temperature exceeds the set temperature, the unit switches to ON status.

The system prioritises local / Modbus control and air probe alarms. This priority ensures that the unit reacts appropriately to the conditions described above.

Input and command status table

Input register	Value	Status
1	0 = Off 1 = On	Shinka probe (room controller)
27	0 = Off 1 = On	Fancoil probe

Coil	Value	Status
1	0=Off 1=On	Shinka probe (room controller)
27	0=Off 1=On	Fancoil probe

LIMITATIONS FROM SOFTWARE

If the air temperature drops below 9°C and the system is switched off with **winter mode** and **antifreeze function** activated, the system automatically switches on to prevent the room from cooling down too much. The system remains switched on until the room temperature reaches a value equal to the minimum temperature limit +1 °C, i.e. by default until 10 °C is reached.

These parameters can be changed via the Shinka interface or with a Modbus command. This allows remote control of the system's settings and safety limits.

Antifreeze setpoint

Coil	Description	Min	Max	Default
48	Changing antifreeze setpoint	0°C	10°C	0 = Off

Antifreeze mode

Coil	Description	Value	Default
4	Enabling antifreeze mode	0=Off 1=On	9°C

SUMMER/WINTER MODE

To change the system's operating mode, the system offers four options:

- **Modbus (via Shinka or BMS)**
- **Digital input**
- **Auto (water temperature-based control)**
- **Auto (air temperature-based control)**

The system automatically changes mode when the temperature falls below, or exceeds, a specific threshold according to the set hysteresis configuration. In the case of water-based control, the consents will be fixed (17-37). In the case of air-based control, consents will be handled via the **neutral zone (ZN)** parameter. You can find this parameter in **management - advanced settings**.

This function allows the system to automatically switch from **summer mode** to **winter mode**, or vice versa, without manual intervention.

In a 4-pipe system with automatic water temperature-based control, the system automatically selects one probe over the other, depending on the set operating mode, to ensure optimal control.

A 4-pipe system includes a configuration with two separate water circuits: one circuit handles hot water and the other handles cold water.

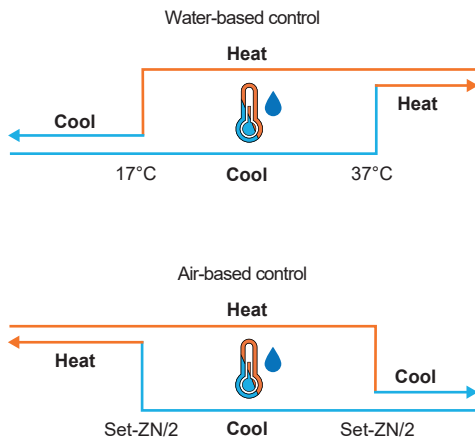

ECONOMY MODE

The system can activate the **Economy mode** via the digital input or the Shinka/BMS interface.

Once this mode is activated, the system automatically applies an offset of 2.5°C to the target temperatures set to improve energy efficiency.

The system adds or subtracts the offset depending on the operating mode, heating or cooling:

- **In heating mode (winter)**, the system subtracts the offset from the target temperature to reduce the heating demand and save energy.
- **In cooling mode (summer)**, the system adds offset to the target temperature to reduce the cooling demand and improve efficiency.

The system also uses these settings in automatic mode, ensuring that Economy mode compensations are automatically applied according to heating or cooling needs.

In the diagram presented, the system sets the normal target temperature at 21°C. With the **Economy mode** activated and an offset of 2°C set on the Shinka, the system changes the target temperature according to heating or cooling requirements. In winter, the system sets the target at 19°C (21°C - 2°C). In summer, the system sets the target at 23°C (21°C + 2°C).

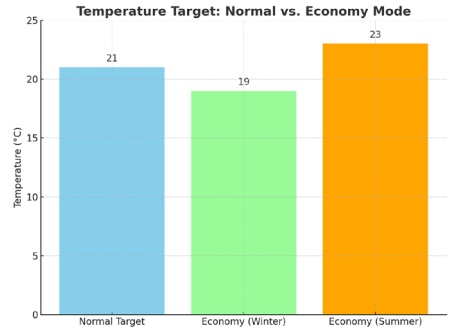

Holding register	Description	Value	Default
32	Modulation of Economy input	1 - 3 °C	2°C

SETPOINT DEFINITION

The setpoint has two separate limits: maximum and minimum for each operating mode, heating and cooling, for a total of four limits:

- **Summer limits:** minimum 14°C, maximum 28°C
- **Winter limits:** minimum 18°C, maximum 32°C

The system activates the **“Enable for Master”** parameter by default. If this parameter is not active, the system does not allow default values to be changed.

Coil	Description	Value	Default
12	Function enabler	0=Off 1=On	1

Setpoint management

By adjusting the setpoint at the interface or the **automatic setpoint (HR7)** from BMS, the seasonal setpoints (**HR1; HR4**) will change accordingly based on the selected season.

A table specifying the setpoints managed by the holding registers is shown alongside.

The system continuously compares the setpoint with the actual temperature, calculating the delta (difference) between the two values. Based on this difference, it determines whether the desired temperature has been reached. The setpoint is considered to have been reached when the difference is between 0.25°C and -0.25°C.

Holding register	Description	Default	Limits
1	Summer setpoint	20°C	Min: Minimum summer setpoint Max: Maximum summer setpoint
2	Minimum summer temperature setpoint	14°C	Min: 14°C Max: Maximum summer setpoint
3	Maximum high temperature setpoint	28°C	Min: Minimum summer setpoint Max: 28°C
4	Winter setpoint	18°C	Min: Minimum winter setpoint Max: Maximum winter setpoint
5	Minimum winter temperature setpoint	18°C	Min: 18°C Max: Maximum winter setpoint
6	Maximum winter temperature setpoint	32°C	Min: Minimum winter setpoint Max: 32°C
7	Automatic setpoint	21°C	Defined limits of the operating mode

START CONSENT

The consent for the fancoil fan to start depends on several conditions that consider various factors:

- **Water temperatures:** for both heating and cooling.
- **Water probe configurations:** check if they are installed correctly or if they are in error.
- **4-pipe unit:** system that distinguishes heating from cooling, relying on separate hot and cold water circuits.

General logic

The system verifies the presence of the water probes as the first step in the operational logic. If no probe is configured, the system always grants start-up consent, allowing the fancoil to operate. This logic is designed to offer optimal control of room comfort. If the water reaches temperatures that do not comply with the setpoint, the system prevents the fancoil from starting up, avoiding the potential discomfort caused by the emission of air that is too hot or too cold.

Cooling mode

If the water sensor is configured, the system grants start consent if the detected temperature is below the target temperature or within the range between the target temperature and the target temperature plus offset.

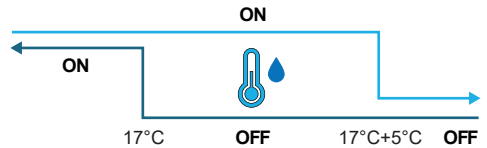

Heating mode

If the water probe is configured, the system grants start consent when the detected temperature exceeds the target temperature or when the detected temperature is between the target temperature and the target temperature minus the offset.

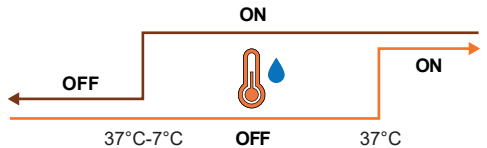

4-pipe unit with two water probes

If the fancoil is configured as a 4-pipe system and two water probes are installed, the activation logic remains the same for heating. In this configuration, the second probe will be installed on the hot tube bundle and will be used to determine the start consent for heating mode.

Holding register	Name	Default	Min	Max	Units of measurement	Description
38	SetpOkClgWtrTar	17	0	25	°C	Cold water-based target consent
39	SetpOkClgWtrHyst	50	0	10	°C	Hysteresis for cold water consent target
40	SetpOkHtgWtrTar	37	10	50	°C	Consent target based on hot water
41	SetpOkHtgWtrHyst	70	0	10	°C	Hysteresis for hot water consent target
42	SetpOkDehumWtrTar	10	0	30	°C	Consent for dehumidification based on relative humidity
43	SetpOkDehumWtrHyst	2	0	10	°C	Hysteresis for dehumidification target consent based on relative humidity
44	SetpOkValveWtrTar	30	0	50	°C	Consent target for valve activation
45	SetpOkValveWtrHyst	5	0	10	°C	Hysteresis for target valve activation consent
46	SetpOkEHtrWtrTar	39	0	50	°C	Consent target for activation of the electric heater
47	SetpOkEHtrWtrHyst	2	0	10	°C	Hysteresis for electrical heater activation consent target

WATER VALVE

The system handles different types of water valves according to configuration. Water valves regulate the flow of hot or cold water through the fan coils.

This setting allows the desired temperature to be maintained.

Types of valves

The system allows the configuration and control of different types of water valves:

- **No valve:** all associated controls are disabled when no valve is installed.
- **On/Off valve:** opens or closes completely, depending on the need to heat or cool the room. Valve control of the valves is via a digital output. See circuit diagram for more information
- **Modulating valve:** finely adjusts the water flow between 0 and 100 % for precise temperature control. Modulation takes place via an analogue 0 - 10 V signal. Refer to the circuit diagram for more information (see **OŽIČENJA**).

- **6-way modulating valve:** specialised valve that manages both hot and cold water flows in a 4-pipe system with a 2-pipe fancoil. This valve uses different voltage levels to control its opening and closing, allowing precise control for both heating and cooling in a single component (see reference section for compatible models).

Opening / Closing

Valve behaviour depends on the air temperature delta, i.e. the difference between the current temperature and the desired setpoint.

Opening	Closing
Air Delta greater than 0.5°C	Air Delta less than or equal to 0

In the case of a modulating valve, the system opens the valve fully when the delta between the setpoint and the measured temperature reaches 3°C.

With the Shinka interface connected, if in summer mode, the valve behaviour also depends on the humidity value measured by the Shinka, according to the following logic:

Opening	Closing
Air Delta greater than 0.5°C	Air Delta less than or equal to -1 and relative humidity greater than 50%

Diagram: 6-way valve operation

The diagram below illustrates how the 6-way valve handles opening and closing depending on the applied voltage:

- **1 - 3.7 V:** valve open for heating (hot water circuit)
- **3.7 - 6.2 V:** valve closed
- **6.2 - 8.9 V:** valve open for cooling (cold water circuit)

This system allows the flow of hot and cold water to be precisely controlled for maximum thermal comfort. The system efficiently controls energy consumption and optimises water flow in the different operating modes of the 2-pipe system.

Refer to the diagram to avoid reverse mounting. In case of reversal, please refer to the specific valve manual.

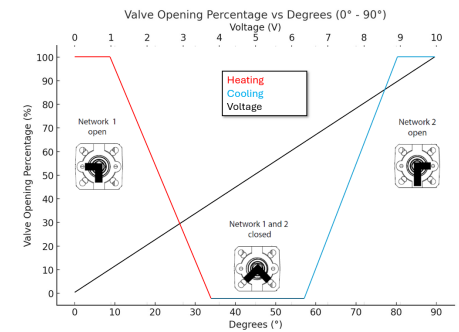
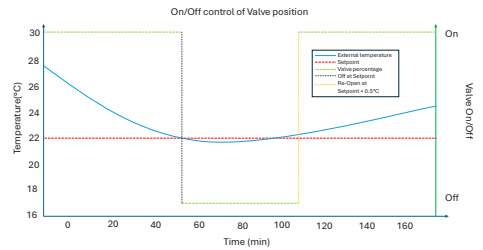
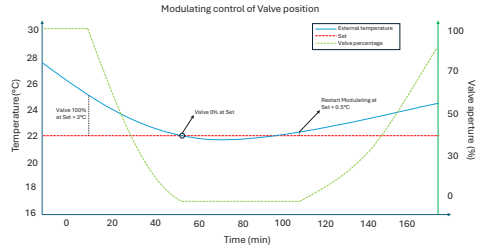

VENTILATION

Fan configurations

The ventilation system can be configured in different ways to respond effectively to environmental variations. These configurations ensure comfort and energy efficiency. Possible configurations include:

1. 3 Step
2. 4 Step
3. Modulating

3-step configuration

In the 3-step automatic mode, the system controls the fans following three speeds. These speeds are based on the difference between the current temperature and the desired setpoint:

- Minimum speed
- Medium speed
- Maximum speed

The **blue line** indicates the activation condition required for switching to the next speed (minimum to maximum).

The **red dotted line** indicates the activation condition required for switching to the previous speed (maximum to minimum).

Timed Hysteresis: the system introduces a 30-second wait when switching between one speed step and the next or previous one. This delay avoids frequent fluctuations and maintains a more stable environment setting.

Note: with a modulating valve, the system must open the valve at least 95% to reach maximum speed. This opening ensures proper air flow and prevents energy wastage.

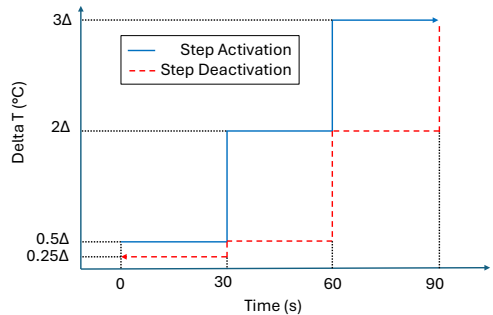

4-step configuration

The 4-step mode introduces an additional trigger threshold. The system handles this additional threshold with the same logic as the 3-step configuration:

- Superminimum speed
- Minimum speed
- Medium speed
- Maximum speed

As in the 3-step configuration, the system also applies a timed hysteresis of 30 seconds. This measure prevents fans from switching on and off too frequently, safeguarding energy efficiency and comfort.

Note: in the presence of a modulating valve, the system must open the valve to at least 95% to switch to maximum speed. This opening ensures proper airflow and prevents energy waste.

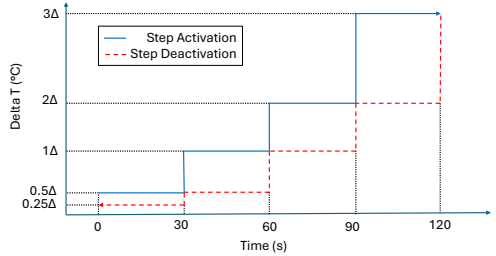

Modulating mode

Modulating fans regulate their speed with a variable voltage between 0 and 10 V DC. This mode allows precise adjustment based on the PI (Proportional-Integral) control signal. This approach allows finely tuned adjustment of fan performance, adapting perfectly to temperature variations and ventilation requirements.

Once the setpoint is reached, the fan will operate at 20%, while it will only shut down completely once the setpoint is exceeded by 1°C (in cooling mode 1°C less, in heating mode more).

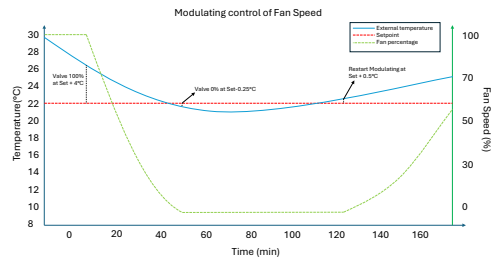

Restrictions

- In application without a valve and with an on-board air temperature probe, the system activates the fan every 10 minutes for 2 minutes at an average speed. This activation enables the correct reading of the probes.
- In summer mode, if a humidity sensor is present, the fans remain active even after reaching the setpoint. The fans switch off when the temperature falls one degree below the target. This practice increases comfort by reducing excessive humidity.

Standby

- **Standby always on:** allows the fan (recirculation) to be kept on, even after the setpoint has been reached. The default speed value in the case of 3/4 step configuration is minimum while in the case of a modulating fan it will be 20%.
- **Standby always off:** as soon as the setpoint is reached, ventilation stops.
- **Standard standby:** the ventilation logic is executed unchanged.

Note: with Shinka it is possible to manage a mixed solution by choosing a different standby parameter for each fancoil.

ELECTRICAL RESISTANCE

The system uses the electrical resistance when the unit or system does not provide enough heat. Even if the system activates this functionality via the Shinka interface, further prerequisites must be fulfilled for the resistance to actually come into operation.

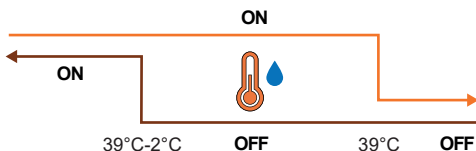

Water consent	Inlet water temperature < electrical resistance water consent setpoint - electrical resistance water consent hysteresis
Temperature reading exceeded by less than 1°C	Air temperature read - target temperature set
Winter Mode	Operating mode

Deactivation condition	
Consent given by the valve	Inlet water temperature ≥ Electrical resistance water consent setpoint

This function also intervenes in fan operation. When active, it forces the fan speed to a medium level. When switched off, the system maintains the average fan speed for two minutes to post-cool the electrical resistance.

DEHUMIDIFICATION CONTROL LOGIC

Purpose of dehumidification

The dehumidification function reduces excessive humidity in the room. When the humidity exceeds the dehumidification setpoint plus hysteresis, the system reduces ventilation to a minimum. The system regulates the fan speed according to the difference between the room temperature and the setpoint, as follows:

- **Step ventilation:** sets the fan speed to medium when the room temperature exceeds the setpoint by more than 1.5°C
- **Modulating ventilation:** creates a dynamic fan ramp based on the distance from the temperature setpoint. The ramp is defined as follows:
 - The fan starts modulating at a speed of 20% when the room temperature exceeds the setpoint by 0.5°C
 - The fan reaches a speed of 50% when the room temperature rises 2.5°C above the setpoint.

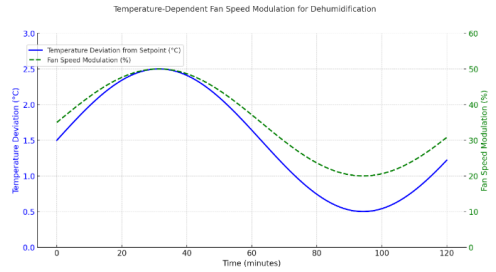

Trigger condition

The system activates dehumidification whenever the humidity exceeds the hysteresis interval. Hysteresis is set to 5% by default, but the value is adjustable between 0% and 50%. This means that if the target humidity is 50%, the system starts dehumidification when the humidity reaches 55%. The system stops dehumidification as soon as the humidity returns to the target value of 50%.

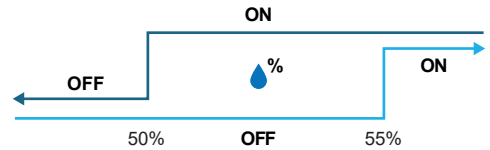

Inhibition condition

The system temporarily suspends the dehumidification function when dehumidification is active and the room temperature is 2°C below the temperature setpoint to avoid discomfort. The system resumes dehumidification when the temperature is within 1.5°C of the setpoint, thus preventing excessive cooling of the room.

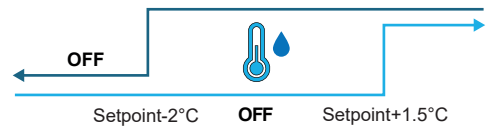

NETWORK AND CONNECTIVITY

RULES FOR CORRECT WIRING

- Always use the same type of cable to make the network.
- The mains cable must not pass through channels intended for cables with dangerous voltages such as 230 Vac or cables carrying high currents, especially if alternating current. Also avoid parallel paths to power cables.
- Wire the cable as loosely as possible. Avoid folds with tight bending radii. Do not wind the cable in hanks.
- Do not twist the cable around power conductors. If it is necessary to cross these conductors, provide a 90° crossing between the cable and the power conductors.
- Keep the cable away from sources of electromagnetic fields, especially from large motors, switchgear, inverters, neon ballasts and antennas of all kinds.
- Do not insert the cable into a cable duct. Avoid all sources of mechanical wear or damage.
- Avoid cable pulling tension exceeding 110 N (11.3 kg) to prevent stretching.
- Evaluate the route in advance in order to shorten it as much as possible. Take note of the addresses of connected instruments, with particular reference to their location in orderly sequence.
- Do not reverse the “+” and “-” polarities at the connection terminals.
- Avoid short cable strands at instrument connection terminations to allow for maintenance without tearing or pulling the cable.
- Identify start and end terminations. Avoid “open” sections.
- Only place 120 Ω termination resistors at the ends of the network. Do not place resistances on every device.
- The maximum length of the BUS connection before adding a repeater or signal amplifier depends on the communication speed, the input impedance, the number of devices connected to the BUS, the electrical characteristics of the cable, and disturbances from the installation environment. Consult the literature for an accurate calculation. In most industrial networks, the number and type of devices used, together with the speeds involved, allow the BUS to reach a length of 1 km, assuming the use of a state-of-the-art cable and an undisturbed environment.
- In the event of integration with a third-party supervision system, make sure that the RS485 communication line connected to the FWEDA fan coil control boards is correctly polarized, according to the recommendations of the RS485 standard. A non-polarized RS485 line may cause instability or malfunctions in Modbus communication between devices.

CONNECTIVITY

The connection between the Shinka and the fancoil control board uses the Modbus protocol.

Each Shinka controls a maximum of 30 fancoils.



FWEDA control board

Modbus RTU



Shinka Touch

The connection is made via RS485 ports:

Control board	RS485/1	Modbus port used for: <ul style="list-style-type: none"> • BMS connection • Connection with the Shinka • Connection between control boards
	RS485/2	
Shinka	RS485/1	Modbus port for BMS connection
	RS485/2	Modbus port for connection with the control board



The control board cannot handle a connection to a Shinka and a BMS simultaneously. To use a BMS see **SHINKA INTEGRATION WITH A BMS SYSTEM**.

The following are installation case studies.

SHINKA + CONTROL BOARD CONNECTION

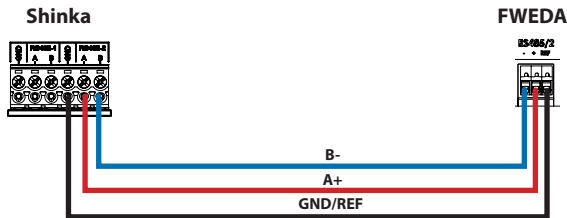

SHINKA + CONTROL BOARD UNIT CONNECTION

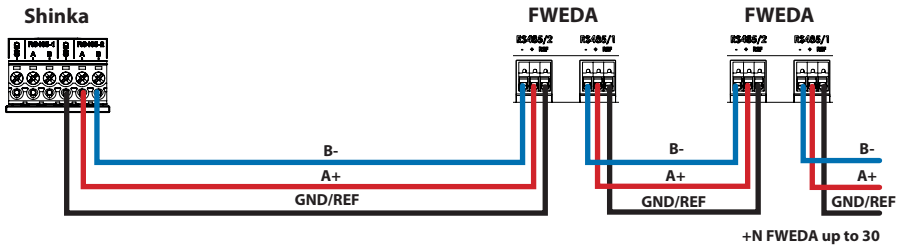

SHINKA + BMS + CONTROL BOARD UNIT CONNECTION

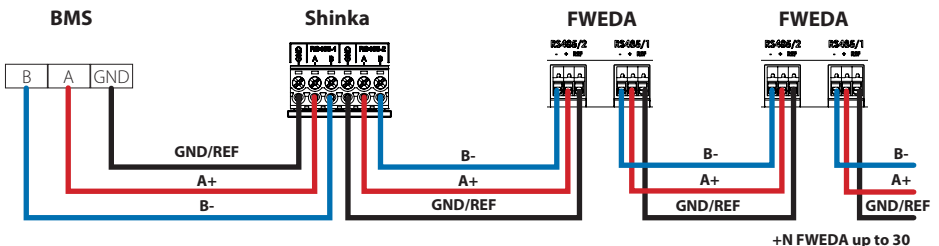

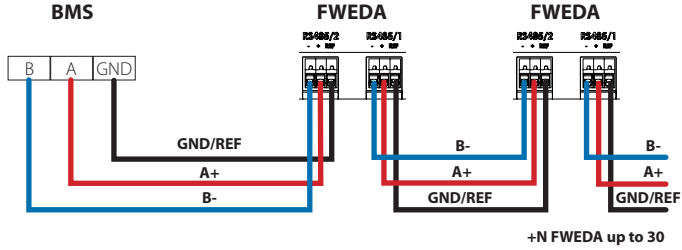
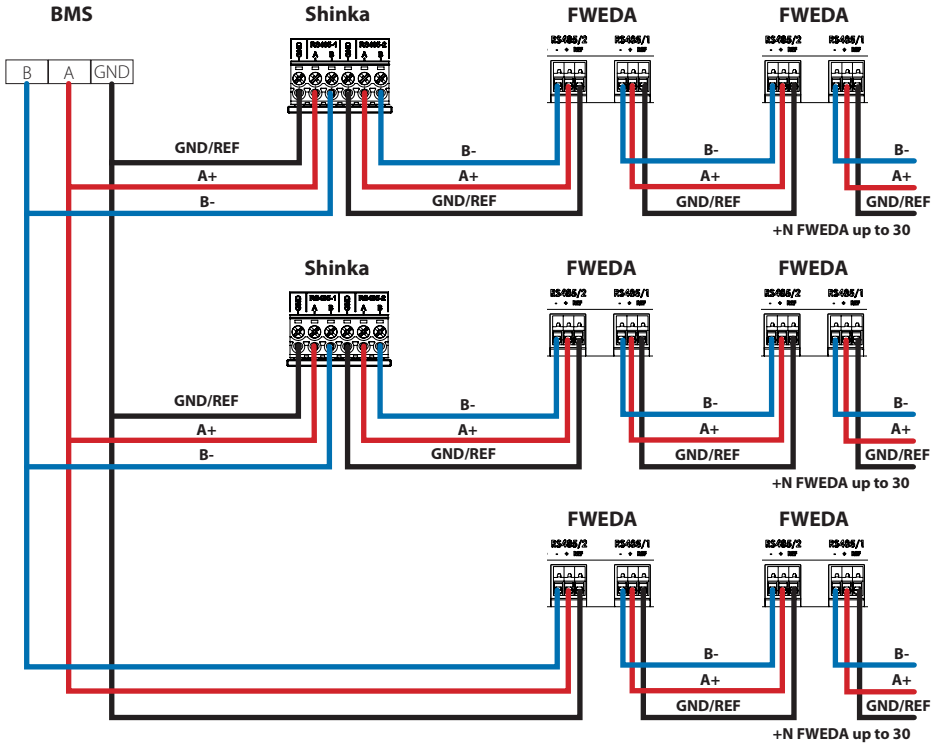
BMS + CONTROL BOARD UNIT CONNECTION

MIXED BMS CONNECTION

The connection must be made via twisted and shielded cable for RS485 application.

Specifications of the RS485 twisted pair cable

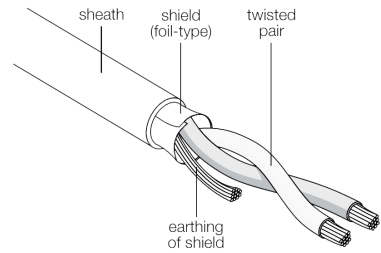
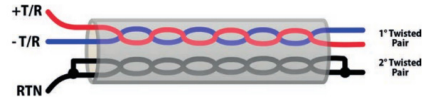
Cable type	RS485 EIA Application
Cable structure	2 twisted, shielded pairs
AWG	22 - 24
Impedance	120 Ω
Working frequency	1 kHz / 1 MHz



Cable example

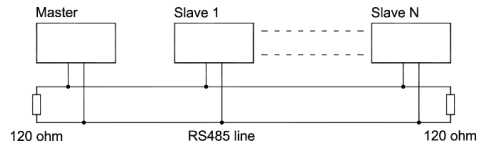

To ensure proper network operation, insert termination resistors on the first and last boards. This action prevents abnormal behaviour and loss of communication over long distances.

SHINKA INTEGRATION WITH A BMS SYSTEM

It is possible to integrate a Modbus network managed by a Shinka within one managed by a BMS. In this case, connect the BMS to the Shinka's Modbus RS485-1 port. Change the Shinka network parameters in the **"Network and Connections"** menu to establish communication between the BMS and the Shinka (see chapter **NETWORK AND CONNECTIVITY** for further details).

Once the communication parameters between the two devices have been correctly configured, it will be possible to read and write the data displayed by the Shinka.

The data displayed by Shinka represent the status and settings of the fancoils in the managed zone.

Please refer to the table below for further details on Shinka's data display logic.

Parameter	Register	Logic
Unit on/off	10001	Exhibit "1" if at least one fancoil in the chain has the activation condition
Summer/Winter Mode	10002	Exposed the value most commonly found in area fancoils
ECONOMY on/off	10003	Exhibit "1" if at least one fancoil in the chain has the activation condition
ANTI-FREEZE on/off	10004	Exhibit "1" if at least one fancoil in the chain has the activation condition
Alarm presence	10005	Exhibit "1" if at least one fancoil in the chain has the activation condition
Air temperature (control) probe in alarm	10006	Exhibit "1" if at least one fancoil in the chain has the activation condition
Cold/hot water temperature probe in alarm	10007	Exhibit "1" if at least one fancoil in the chain has the activation condition
Hot water temperature probe in alarm	10008	Exhibit "1" if at least one fancoil in the chain has the activation condition
Humidity probe in alarm	10009	Exhibit "1" if at least one fancoil in the chain has the activation condition
Number of ventilation steps (3/4)	10010	Exposed maximum value of zone fan coils
Number of pipes (2/4)	10011	Exposed maximum value of zone fan coils
Type of ventilation (Step/Modulating)	10012	Exposed the value most commonly found in area fancoils
Probe used (DISPLAY/Remote)	10013	Exhibit "1" if at least one fancoil in the chain has the activation condition
Installed electrical resistance	10014	Exhibit "1" if at least one fancoil in the chain has the activation condition
Status Digital output 1 (DO1)	10016	Exhibit "1" if at least one fancoil in the chain has the activation condition
Status Digital output 2 (DO2)	10017	Exhibit "1" if at least one fancoil in the chain has the activation condition
Status Digital output 3 (DO3)	10018	Exhibit "1" if at least one fancoil in the chain has the activation condition
Status Digital output 4 (DO4)	10019	Exhibit "1" if at least one fancoil in the chain has the activation condition
Status Digital output 5 (DO5)	10020	Exhibit "1" if at least one fancoil in the chain has the activation condition
Status Digital output 6 (DO6)	10021	Exhibit "1" if at least one fancoil in the chain has the activation condition
Status Digital output 7 (DO7)	10022	Exhibit "1" if at least one fancoil in the chain has the activation condition
Presence of cold/hot water probe	10023	Exhibit "1" if at least one fancoil in the chain has the activation condition
Hot water probe presence (4 pipes)	10024	Exhibit "1" if at least one fancoil in the chain has the activation condition

Parameter	Register	Logic
Active dehumidification	10025	Exhibit "1" if at least one fancoil in the chain has the activation condition
Open valve	10026	Exhibit "1" if at least one fancoil in the chain has the activation condition
Unit switched on by remote contact	10027	Exhibit "1" if at least one fancoil in the chain has the activation condition
Ventilation control (Manual/Automatic)	10028	Exhibit "1" if at least one fancoil in the chain has the activation condition
Electrical resistance active	10029	Exhibit "1" if at least one fancoil in the chain has the activation condition
Shinka air temperature probe in alarm	10034	Exposed 1 if alarm reported by Shinka, 0 otherwise
Modbus disconnection alarm	10038	Exposed 1 if alarm reported by Shinka, 0 otherwise
Air temperature (control)	30001	Exposed average temperature of zone fan coils
Relative humidity	30002	Exposed Shinka humidity reading
Water temperature (cold/warm)	30003	Exposed average temperature of zone fan coils
Hot water temperature	30004	Exposed average temperature of zone fan coils
Step ventilation status	30005	Exposed maximum step value of zone fancoils
% Modulating ventilation	30006	Exposed average value of fan coils with modulating fan in the zone
% Value AO1	30007	Exposed average value of fan coils with modulating fan in the zone
% Value AO2	30008	Exposed average value of fan coils with modulating valve in the zone
% Value AO3	30009	Exposed average value of fan coils with modulating valve and four-pipe configuration in the zone
Active temperature setpoint	30010	Exposed value set on Shinka
Summer temperature setpoint	30011	Exposed value set on Shinka
Winter temperature setpoint	30012	Exposed value set on Shinka
Single temperature setpoint	30013	Exposed value set on Shinka
Humidity setpoint	30014	Exposed value set on Shinka
Valve type	30015	Exposed maximum value of zone fan coils
Supply air probe alarm	30025	Exposed maximum value of zone fan coils
Fancoil remote probe alarm	30026	Exposed maximum value of zone fan coils
Fancoil water consent	30027	Exposed maximum value of zone fan coils

When the BMS writes a parameter to the Shinka, the latter propagates the information to all FWEDA boards. If the Shinka interface changes a command or setting locally, this change overwrites the previous BMS command.



The Shinka reads the operational data of the connected fan coils every 2 minutes. The Shinka temporarily stores this data and makes it available to the BMS connected via RS485. As a result, the BMS accesses updated data every 2 minutes, in line with the Shinka's update frequency.



To change Setpoint Min and Max values, ensure that the new lower limit is lower than the previous Setpoint Max and the upper limit is higher than the previous Setpoint Min.

If you also wish to change the Setpoint along with the Min and Max limits, check that it is within the previously set limits, otherwise update the limits first.

MAPPING

All Modbus registers are 16-bit.

COIL STATUS

Description	Declaration	Data Type	Modbus Type	R/RW (Control card)	Address	Gain	Measure Unit	Range description	Default
MASTER control - ON/OFF	BOOL	BOOL	Coil status	RW	00001	-	-	0=Off 1=On	1
MASTER control - SUMMER/WINTER	BOOL	BOOL	Coil status	RW	00002	-	-	0=Summer 1=Winter	0
MASTER control - ECONOMY	BOOL	BOOL	Coil status	RW	00003	-	-	0=Off 1=On	0
MASTER control - ANTIFREEZE ENABLING	BOOL	BOOL	Coil status	RW	00004	-	-	0= No 1= Yes	0
MASTER control - ELECTRICAL RESISTANCE ENABLING	BOOL	BOOL	Coil status	RW	00005	-	-	0= No 1= Yes	0
MASTER control - Fan MAN/AUTO	BOOL	BOOL	Coil status	RW	00006	-	-	0=MAN 1=AUTO	0
Enabling ON/OFF from MASTER	BOOL	BOOL	Coil status	RW	00007	-	-	0= No 1= Yes	1
Enabling ECONOMY from MASTER	BOOL	BOOL	Coil status	RW	00008	-	-	0= No 1= Yes	1
SUMMER/WINTER enabling from MASTER	BOOL	BOOL	Coil status	RW	00009	-	-	0= No 1= Yes	1
ANTIFREEZE enabling from MASTER	BOOL	BOOL	Coil status	RW	00010	-	-	0= No 1= Yes	1
ELECTRICAL RESISTANCE enabling from MASTER	BOOL	BOOL	Coil status	RW	00011	-	-	0= No 1= Yes	1
SETPOINT enabling from MASTER	BOOL	BOOL	Coil status	RW	00012	-	-	0= No 1= Yes	1
SETPOINT LIMITS enabling from MASTER	BOOL	BOOL	Coil status	RW	00013	-	-	0= No 1= Yes	1
FAN SPEED enabling from MASTER	BOOL	BOOL	Coil status	RW	00014	-	-	0= No 1= Yes	1
HUMIDITY CONTROL enabling consent from MASTER	BOOL	BOOL	Coil status	RW	00016	-	-	0= No 1= Yes	1
HUMIDITY CONTROL enabling	BOOL	BOOL	Coil status	RW	00017	-	-	0= No 1= Yes	1

INPUT STATUS

Description	Declaration	Data Type	Modbus Type	R/RW (Control board)	Address	Gain	Measure Unit	Range description	Default
ON/OFF hydronic terminal	BOOL	BOOL	Input status	R	10001	-	-	0=Off 1=On	-
SUMMER/WINTER	BOOL	BOOL	Input status	R	10002	-	-	0=Summer 1=Winter	-
ECONOMY active	BOOL	BOOL	Input status	R	10003	-	-	0=Off 1=On	-
ANTIFREEZE active	BOOL	BOOL	Input status	R	10004	-	-	0=Off 1=On	-
ALARM presence	BOOL	BOOL	Input status	R	10005	-	-	0=No Alarm 1=Active Alarm	-
Room temperature probe alarm	BOOL	BOOL	Input status	R	10006	-	-	0=No Alarm 1=Active Alarm	-
Water temperature probe alarm	BOOL	BOOL	Input status	R	10007	-	-	0=No Alarm 1=Active Alarm	-
Hot water temperature probe alarm	BOOL	BOOL	Input status	R	10008	-	-	0=No Alarm 1=Active Alarm	-
Room humidity probe alarm	BOOL	BOOL	Input status	R	10009	-	-	0=No Alarm 1=Active Alarm	-
Speed number	BOOL	BOOL	Input status	R	10010	-	-	0=3 speed 1=4 speed	-
Number of pipes (2/4)	BOOL	BOOL	Input status	R	10011	-	-	0=2 pipes 1=4 pipes	-
Ventilation type	BOOL	BOOL	Input status	R	10012	-	-	0=Step 1=Modulating	-
Control probe (Room Temperature)	BOOL	BOOL	Input status	R	10013	-	-	0= Shinka 1=Control board	-
Presence of electrical resistances	BOOL	BOOL	Input status	R	10014	-	-	0=No 1=Yes	-
Humidity probe presence	BOOL	BOOL	Input status	R	10015	-	-	0=No 1=Yes	-
Status of digital output 1 (O1)	BOOL	BOOL	Input status	R	10016	-	-	0=Off 1=On	-
Status of digital output 2 (O2)	BOOL	BOOL	Input status	R	10017	-	-	0=Off 1=On	-
Status of digital output 3 (O3)	BOOL	BOOL	Input status	R	10018	-	-	0=Off 1=On	-
Status of digital output 4 (O4)	BOOL	BOOL	Input status	R	10019	-	-	0=Off 1=On	-
Status of digital output 5 (O5)	BOOL	BOOL	Input status	R	10020	-	-	0=Off 1=On	-
Status of digital output 6 (O6)	BOOL	BOOL	Input status	R	10021	-	-	0=Off 1=On	-
Status of digital output 7 (O7)	BOOL	BOOL	Input status	R	10022	-	-	0=Off 1=On	-
Water probe presence	BOOL	BOOL	Input status	R	10023	-	-	0=No 1=Yes	-

Description	Declaration	Data Type	Modbus Type	R/RW (Control board)	Address	Gain	Measure Unit	Range description	Default
Hot water probe presence (4-pipe hydronic terminal)	BOOL	BOOL	Input status	R	10024	-	-	0=No 1=Yes	-
Dehumidification active	BOOL	BOOL	Input status	R	10025	-	-	0=Off 1=On	-
Valve open	BOOL	BOOL	Input status	R	10026	-	-	0=Off 1=On	-
Hydronic terminal switched off by remote contact	BOOL	BOOL	Input status	R	10027	-	-	0=Remote off not activated 1=Remote off activated	-
Ventilation adjustment (MANUAL/AUTOMATIC)	BOOL	BOOL	Input status	R	10028	-	-	0=MAN 1=AUTO	-
Resistance active	BOOL	BOOL	Input status	R	10029	-	-	0=Off 1=On	-
Valve presence	BOOL	BOOL	Input status	R	10030	-	-	0=No 1=Yes	-
ECONOMY enabling from contact	BOOL	BOOL	Input status	R	10031	-	-	0=No 1=Yes	-
Shinka global alarm (not present on control board)	BOOL	BOOL	Input status	R	10033	-	-	0=No 1=Yes	-
Shinka temperature probe alarm (not present on control board)	BOOL	BOOL	Input status	R	10034	-	-	0=No 1=Yes	-
Shinka humidity probe alarm (not on control board)	BOOL	BOOL	Input status	R	10037	-	-	0=No 1=Yes	-
Shinka Modbus communication alarm (not present on control board)	BOOL	BOOL	Input status	R	10038	-	-	0=No 1=Yes	-

INPUT REGISTER

Description	Declaration	Data Type	Modbus Type	R/RW (Control board)	Address	Gain	Measure Unit	Range description	Default
Control temperature	REAL	SIGNED WORD	Input register	R	30001	0.1	°C	-	-
Relative humidity read by Shinka	UINT	UNSIGNED WORD	Input register	R	30002	1.0	%	-	-
Cold water temperature	REAL	SIGNED WORD	Input register	R	30003	0.1	°C	-	-
Hot water temperature	REAL	SIGNED WORD	Input register	R	30004	0.1	°C	-	-
Step ventilation status	UINT	UNSIGNED WORD	Input register	R	30005	0	-	0= Ventilation stopped 1 = Superminimum 2= Minimum 3=Medium 4=Maximum	-
Value % of modulating ventilation	REAL	SIGNED WORD	Input register	R	30006	1.0	%	0 - 100	-
Value % of analogue output 1	REAL	SIGNED WORD	Input register	R	30007	1.0	%	0 - 100	-
Value % of analogue output 2	REAL	SIGNED WORD	Input register	R	30008	1.0	%	0 - 100	-
Value % of analogue output 3	REAL	SIGNED WORD	Input register	R	30009	1.0	%	0 - 100	-
Active temperature SET	REAL	SIGNED WORD	Input register	R	30010	0.1	°C	140 - 320	-
Summer temperature SET	REAL	SIGNED WORD	Input register	R	30011	0.1	°C	140 - 280	-
Winter temperature SET	REAL	SIGNED WORD	Input register	R	30012	0.1	°C	180 - 320	-
Unique temperature SET (if SUM/WIN on water/air temp.)	REAL	SIGNED WORD	Input register	R	30013	0.1	°C	140 - 320	-
Active humidity SET	REAL	SIGNED WORD	Input register	R	30014	1.0	%	-	-
Valve type	UINT	UNSIGNED WORD	Input register	R	30015	0	-	0=No 1=OnOff 2 = Modulating	-
Supply air temperature value	REAL	SIGNED WORD	Input register	R	30019	1	°C	-20 - 110	-
Room temperature value	REAL	SIGNED WORD	Input register	R	30020	1	°C	-20 - 110	-
Value % of analogue output 4	REAL	SIGNED WORD	Input register	R	30021	1	%	0 - 100	-
Supply Air Temperature Alarm Presence	UINT	UNSIGNED WORD	Input register	R	30025	1		0-2	0
Fancoil Probe Air Temperature Alarm Presence	UINT	UNSIGNED WORD	Input register	R	30026	1		0-1	0
Fancoil Water Consent (Cooling / Heating)	UINT	UNSIGNED WORD	Input register	R	30027	1		0-2	0

HOLDING REGISTER

Description	Declaration	Data Type	Modbus Type	R/RW (Control board)	Address	Gain	Measure Unit	Range description	Default
Summer temperature SET	REAL	SIGNED WORD	Holding register	RW	40001	0.1	°C	140 - 280	200
Minimum summer temperature SET limit	REAL	SIGNED WORD	Holding register	RW	40002	0.1	°C	140 - 280	140
Maximum summer temperature SET limit	REAL	SIGNED WORD	Holding register	RW	40003	0.1	°C	140 - 280	280
Winter temperature SET (heating)	REAL	SIGNED WORD	Holding register	RW	40004	0.1	°C	180 - 320	220
Minimum winter temperature SET limit	REAL	SIGNED WORD	Holding register	RW	40005	0.1	°C	180 - 320	180
Maximum winter temperature SET limit	REAL	SIGNED WORD	Holding register	RW	40006	0.1	°C	180 - 320	320
Unique temperature SET (if SUM/WIN on water/air temp.)	REAL	SIGNED WORD	Holding register	RW	40007	0.1	°C	140 - 320	210
Humidity SET	REAL	SIGNED WORD	Holding register	RW	40008	1	%	1 - 100	45
Minimum humidity SET limit	REAL	SIGNED WORD	Holding register	RW	40009	1	%	1 - 100	15
Maximum humidity SET limit	REAL	SIGNED WORD	Holding register	RW	40010	1	%	1 - 100	60
Step ventilation speed	UINT	UNSIGNED WORD	Holding register	RW	40011	1	-	0= Superminimum 1= Minimum 2=Medium 3=Maximum	0
Modulating ventilation speed	REAL	SIGNED WORD	Holding register	RW	40012	1	%	1 - 100	0
Minimum value of modulating ventilation	REAL	SIGNED WORD	Holding register	RW	40029	0.1	%	0 - 50	20
Maximum value of modulating fan - COLD	REAL	SIGNED WORD	Holding register	RW	40030	0.1	%	50 - 100	100
Maximum value of modulating fan - HEAT	REAL	SIGNED WORD	Holding register	RW	40031	0.1	%	50 - 100	100
Economy Hysteresis	UINT	UNSIGNED WORD	Holding register	RW	40032	0.1	°C	0 - 100	25
Humidity hysteresis	UINT	UNSIGNED WORD	Holding register	RW	40033	1.0	%	0 - 50	5
Neutral Zone	UINT	UNSIGNED WORD	Holding register	RW	40034	0.1	°C	0 - 100	20
Room air probe offset	REAL	SIGNED WORD	Holding register	RW	40035	0.1	°C	-30 - 30	0

Description	Declaration	Data Type	Modbus Type	R/RW (Control board)	Address	Gain	Measure Unit	Range description	Default
Cold water probe offset	REAL	SIGNED WORD	Holding register	RW	40036	0.1	°C	-30 - 30	0
Hot water probe offset	REAL	SIGNED WORD	Holding register	RW	40037	0.1	°C	-30 - 30	0
Cooling water consent setpoint	REAL	SIGNED WORD	Holding register	RW	40038	0.1	°C	0 - 250	170
Cooling water consent hysteresis	REAL	SIGNED WORD	Holding register	RW	40039	0.1	°C	0 - 100	50
Heating water consent setpoint	REAL	SIGNED WORD	Holding register	RW	40040	0.1	°C	100 - 500	370
Heating water consent hysteresis	REAL	SIGNED WORD	Holding register	RW	40041	0.1	°C	0 - 100	70
Dehumidification water consent setpoint	REAL	SIGNED WORD	Holding register	RW	40042	0.1	°C	0 - 300	100
Dehumidification water consent hysteresis	REAL	SIGNED WORD	Holding register	RW	40043	0.1	°C	0 - 100	20
Valve water consent setpoint	REAL	SIGNED WORD	Holding register	RW	40044	0.1	°C	0 - 500	300
Valve water consent hysteresis	REAL	SIGNED WORD	Holding register	RW	40045	0.1	°C	0 - 100	50
Electrical resistance water consent setpoint	REAL	SIGNED WORD	Holding register	RW	40046	0.1	°C	0 - 500	390
Electrical resistance water consent hysteresis	REAL	SIGNED WORD	Holding register	RW	40047	0.1	°C	0 - 100	20
Minimum temperature control setpoint	REAL	SIGNED WORD	Holding register	RW	40048	0.1	°C	0 - 100	90
Minimum temperature control hysteresis	REAL	SIGNED WORD	Holding register	RW	40049	0.1	°C	0 - 100	10
Supply air probe offset	REAL	SIGNED WORD	Holding register	RW	40050	0.1	°C	-50 - 50	0

ALARMS

Identification name	Generate by	Class	Description
Global	Control Board	Warning	Can only be used as alarm/warning notification data by a BMS.
Temp. probe PCB	Control Board	Alarm	Room temperature probe in fault, check and replace probe to reactivate the fancoil unit.
Temp. sens. RC	Control Board	Warning	Room controller temperature probe in fault.
Rem. probe PCB	Control Board	Warning	Remote fancoil temperature probe in fault.
Cold water probe	Control Board	Warning	Water probe in fault, check and replace probe. Consent logic deactivated.
Hot water probe	Control Board	Warning	Hot water probe in fault, check and replace probe. Consent logic deactivated.
Air temp. probe	Control Board	Warning	Supply temperature probe in fault, check and replace probe.
RC type	Control Board	Warning	Room Controller type to "No", the dehumidification function was disabled until the error was resolved.
Humidity sens.	Shinka	Warning	Humidity probe in fault, dehumidification function disabled until fault rectification.
Bright. sens. RC	Shinka	Warning	The brightness probe is in alarm, the automatic brightness function has been disabled until the error is resolved.
Prox. sens. RC	Shinka	Warning	The proximity sensor is in alarm, the display activation function on approach has been disabled until the error is resolved.
Scheduling off	Shinka	Warning	Tomorrow DD/MM/YYYY the system will be switched off as per the active schedule. If you wish to change the OFF days, enter the schedule and change the settings.
Cold water cons.	Shinka	Warning	The water temperature is above the setpoint, the fan will remain off until the required temperature conditions are reached.
Hot water cons.	Shinka	Warning	The water temperature is below the setpoint, the fan will remain off until the required temperature conditions are reached.
Modbus	Shinka	Alarm	The Room Controller has lost communication with its fancoil(s), check the system's wiring and Modbus configuration.
Global warning	Shinka	Alarm	Can only be used as alarm/warning notification data by a BMS.

EN WIRING DIAGRAMS

	EN
F	Phase
N	Neutral
PE	Earth/mass
Ref	Reference/Mass
+	A+
-	B-
V1	Speed 1
V2	Speed 2
V3	Speed 3
V4	Speed 4
COM	Common
SW	Cooling water temperature probe
SWH	Heating water temperature probe
SAE	Supply air temperature probe
SR	Room temperature probe
EH	Electric heater
VC	Cooling water valve
VH	Heating water valve
LD1	Status LED 1
LD2	Status LED 2
BLDC	Brushless DC motor
AC	AC motor

EN AC MOTOR + 6-WAY VALVE (IT)

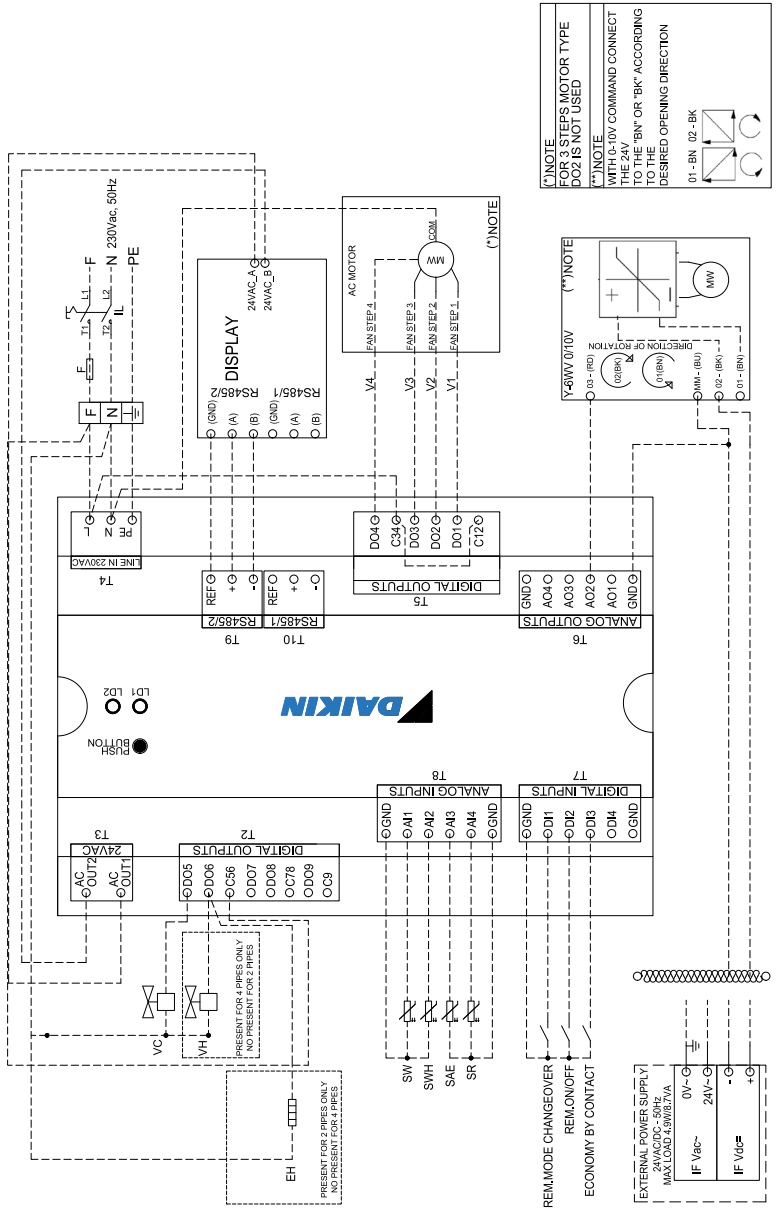

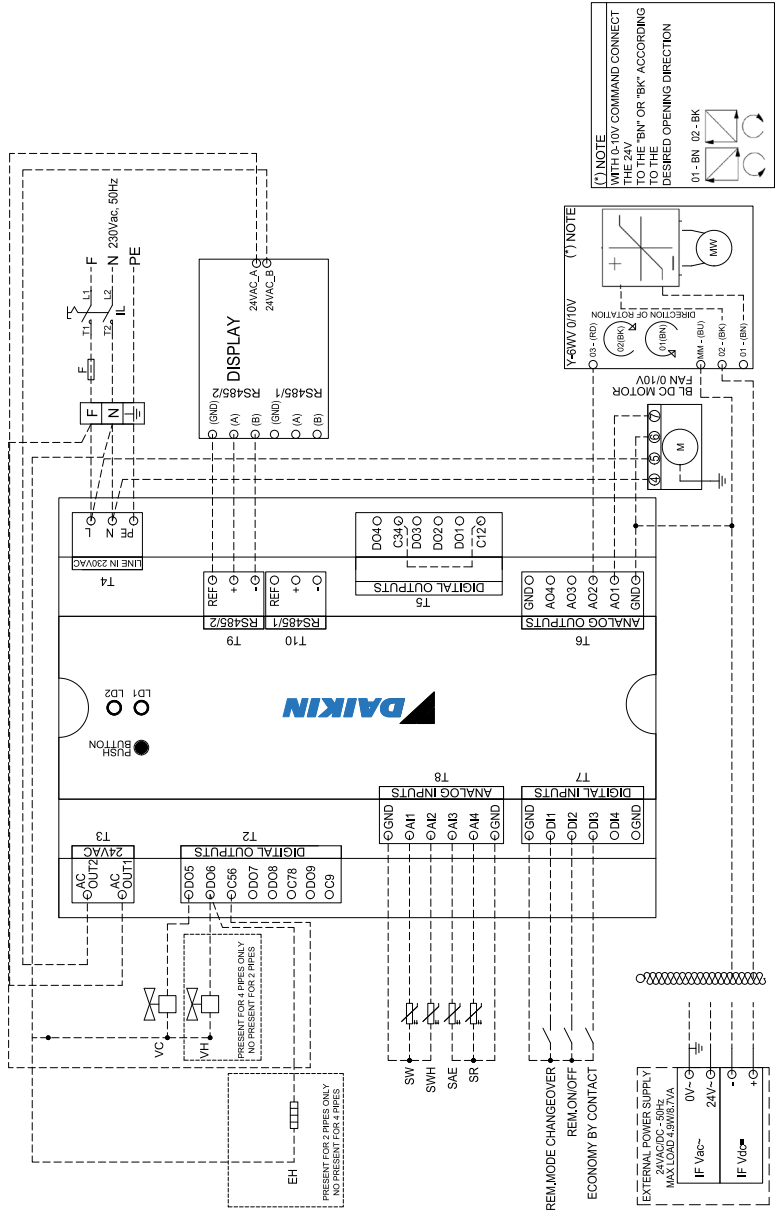
EN BLDc MOTOR + 6-WAY VALVE (IT)

EN AC MOTOR

